

GHC75 Product Guide

ASME B30.5
Metric 75% and Imperial 75%



Features

- 70 t (75 USt) capacity
- 11 m – 36 m (36 ft – 118 ft 1 in) four-section power boom
- 15 m (49 ft 3 in) offsettable boom extension
- 100% pick and carry load chart
- Cummins QSB 6.7L Tier 4 final compliant engine

GROVE GHC75

The mid-range GHC75 delivers powerful agility and boom length of 11 m – 36 m (36 ft – 118 ft 1 in).

Features

> Comfort redefined

Operator cab is designed to deliver maximum comfort while incorporating conveniently located joystick controls for precise operation. Cab comes equipped with an integrated rated capacity limiter, air suspension seat, color monitor for up to four cameras and precise climate control. The cab can tilt up to 20° providing the operator additional comfort when working at long boom and extension lengths.



> Travel made easy

Transportation to the jobsite can easily be accomplished in one to two loads. Setup time is minimal thanks to the GHC75's quick self-assembly system and hydraulically installed counterweights. When set up the strong undercarriage provides 100 percent pick and carry capability and work up to 4° of inclination. The hydraulically extendable tracks allow for maximum flexibility on the jobsite.



> Strong telescopic boom

The GHC75 comes equipped with a robust full-power four-section boom that allows for telescoping under load. The main boom offers 11 m – 36 m (36 ft – 118 ft 1 in) of reach. This paired with the standard 8 m (26 ft 3 in) offsettable swingaway extension provides a max tip height of 46 m (151 ft).



> CraneSTAR is an exclusive and innovative crane asset management system

that helps improve your profitability and reduce costs by remotely monitoring critical crane data. Visit www.cranestar.com for more information.

GHC75 benefits

More productive in more places on the jobsite

The GHC75 delivers unsurpassed maneuverability and versatility.

- Telescoping boom, plus heavy-duty crawler tracks for all-terrain productivity
- Superior gradeability
- High visibility cabs with up to 20° tilt
- Two-speed hydrostatic drive allows for skid steering and counter-rotation capability
- Compact design allows you to work in more places

Rugged durability to tackle all terrain

The GHC75 comes equipped with a durable, powerful crawler system.

- Hydraulically extendable and retractable crawlers
- Heavy-duty, 900 mm (36 in) triple bar, maintenance-free track shoes
- Cummins QSB Tier 3 or Tier 4 final diesel engines power through terrain challenges

Easy transport to the jobsite and quick assembly

The GHC75 helps you spend less time on the truck and more time on the job.

- Transports to the jobsite in one to two loads
- Retracted gauge for transport width
- Self-assembly counterweight
- Excellent serviceability keeps you up and running



Manitowoc Crane Care when you need it.
The assurance of the world's most advanced crane service and support to get you back to work fast.



Manitowoc Finance helps you get right to work generating profits for your business.
Financial tools that help you capitalize on opportunity with solutions that fit your needs.

Contents

- Dimensions 5
- Load programs 7
- Transportation/ assembly 8
- Working range/ load charts – main boom metric 75% 9
- Working range/load charts – extensions metric 75% 12
- Working range/ load charts – main boom imperial 75% 15
- Working range/ load charts – extensions imperial 75% 18
- Load handling 21
- Specifications 22
- Symbols glossary 24

Dimensions

Transport dimensions and weights

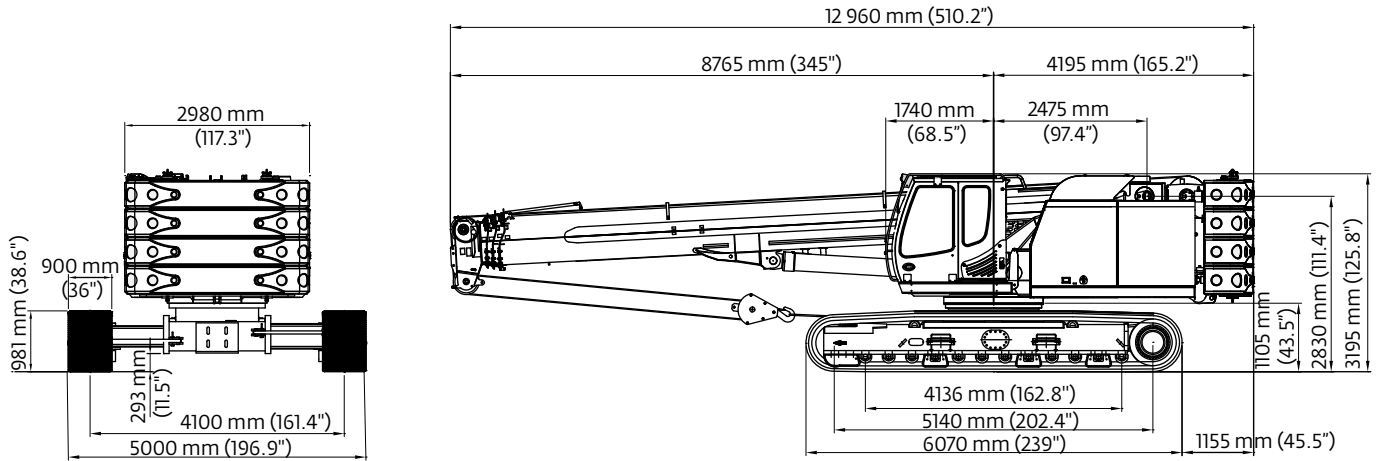

Operating weight: approximately 71 760 kg (158,200 lb) (with 8 m (26 ft 3 in) boom extension, 2 hoists, 900 mm (36 in) triple bar shoes, 17 440 kg (38,450 lb) counterweight and 8 000 kg (17,637 lb) carbody counterweight).

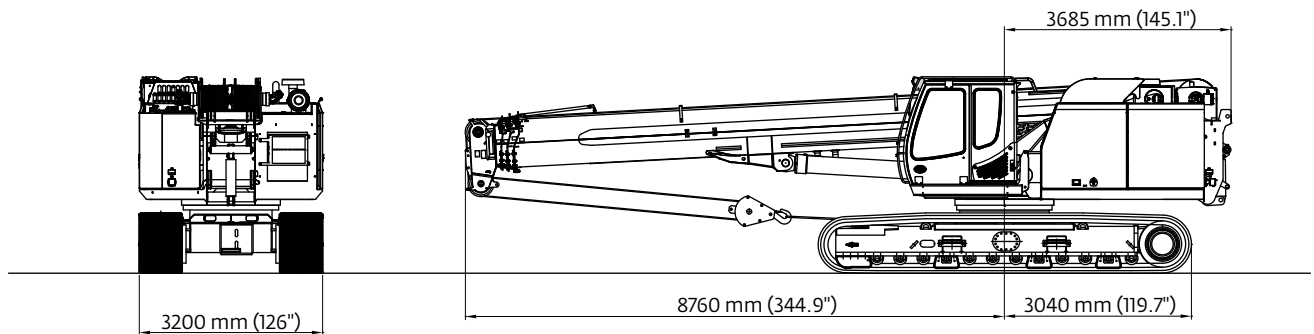





Transport weight: approximately 46 320 kg (102,113 lb) with (8 m (26 ft 3 in) boom extension, 2 hoists, without counterweight, without carbody counterweight).

Transport weight: approximately 54 320 kg (119,750 lb) with (8 m (26 ft 3 in) boom extension, 2 hoists, without counterweight, with carbody counterweight).

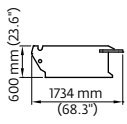
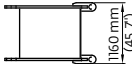
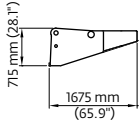
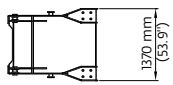
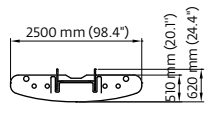
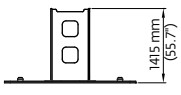
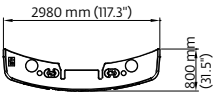

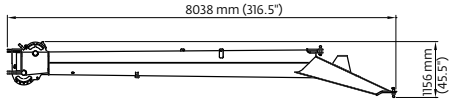
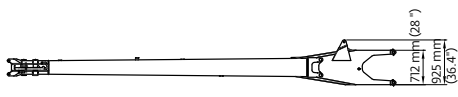
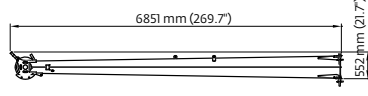
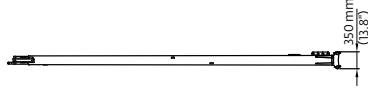
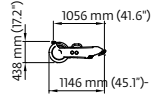







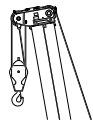

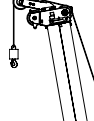

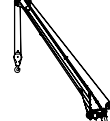























Dimensions

Transport dimensions and weights

 	Carbody counterweight	2x	4000 kg (8818.5 lb)
 	Counterweight support arm	1x	590 kg (1300 lb)
 	Base plate for counterweight	1x	440 kg (970 lb)
 	Counterweight	4x	4250 kg (9370 lb)
 	Boom extension - 8 m (26 ft 3 in)		730 kg (1609 lb)
 	Fly jib extension - 7 m (23 ft)		305 kg (672 lb)
 	Auxiliary boom nose		50 kg (110 lb)

Load programs

Working load programs

		Main boom		Auxiliary boom nose		Boom Extension 8 m (26 ft 3 in)		Boom Extension w/ optional fly jib 15 m (49 ft 3 in)	
									
Undercarriage track width (centerline to centerline of crawlers)		 4,1 m (13' 6")	 3,2 m (10' 6")	 4,1 m (13' 6")	 3,2 m (10' 6")	 4,1 m (13' 6")	 3,2 m (10' 6")	 4,1 m (13' 6")	 3,2 m (10' 6")
Counterweight	Carbody counterweight								
 17,4 t (38,450 lb)	 8,0 t (17,637 lb)	360° 	360° 	360° 	360° 	360° 	—	360° 	—
 8,9 t (19,710 lb)	 8,0 t (17,637 lb)	360° 	360° 	360° 	360° 	—	—	—	—
 8,9 t (19,710 lb)	 0 t	360° 	—	360° 	—	—	—	—	—
 0 t	 0 t	360° 	—	360° 	—	—	—	—	—

NOTE: Additional safe working loads are also available for 2° and 4° inclines.

Boom Extension options

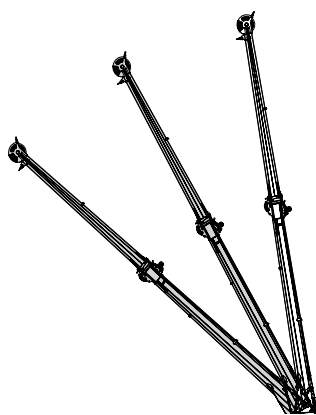

• **Boom Extension 8 m (26 ft 3 in)** 
maximum 2-strand, possible offset angle 0°/20°/40°

• **Boom Extension w/ optional fly jib 15 m (49 ft 3 in)** 
maximum 1-strand, Offset angle 0°/20°/40°

• **Auxiliary boom nose**
maximum 1-strand

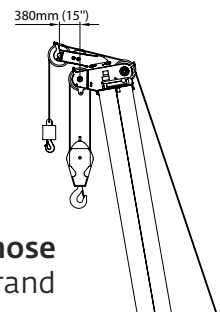

THIS CHART IS ONLY A GUIDE AND SHOULD NOT BE USED TO OPERATE THE CRANE.
The individual crane's load chart, operating instructions and other instructional plates must be read and understood prior to operating the crane.

Transportation / assembly

Self assembly system

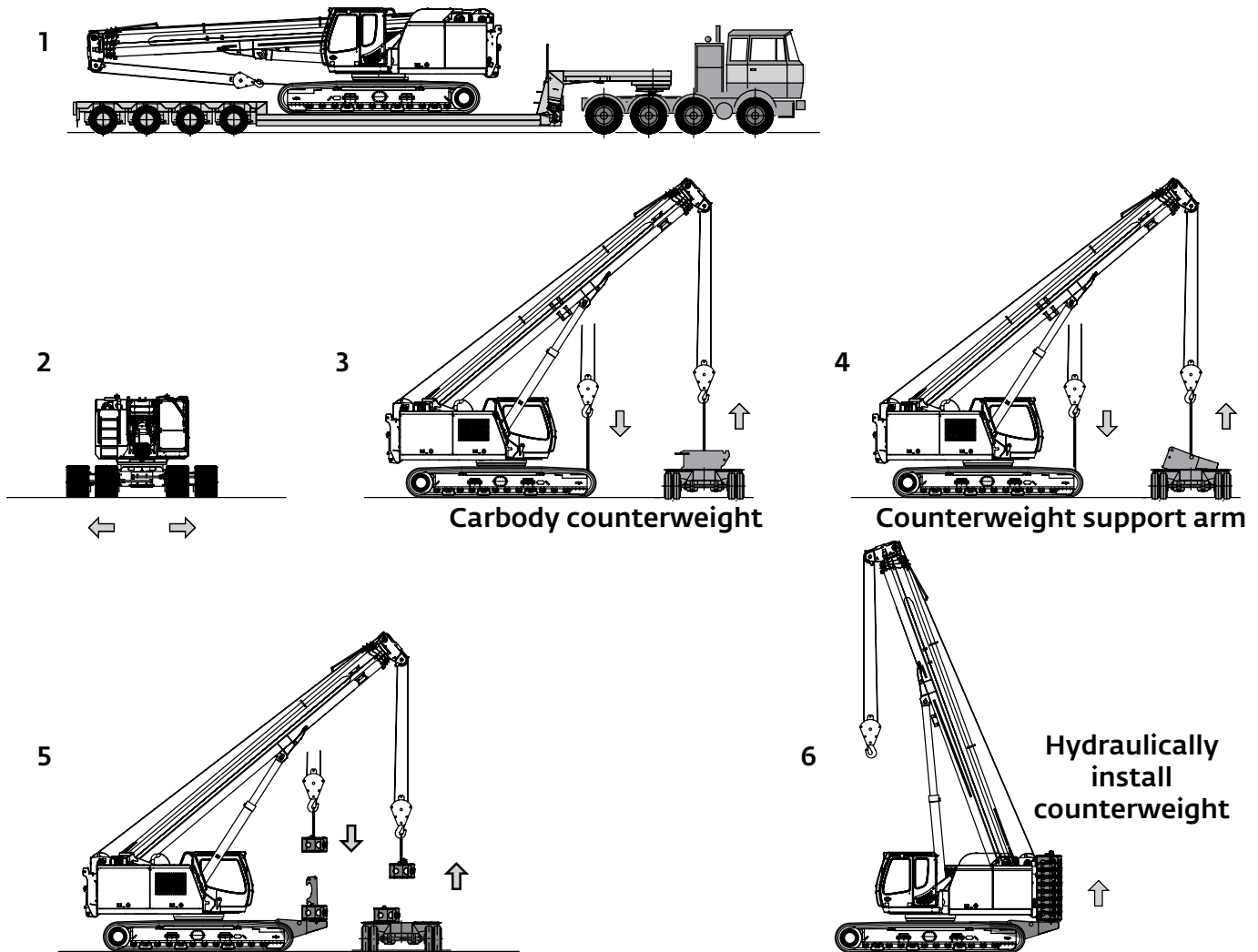

Hooks

Capacity	Weight	Cable reeving and maximum safe working load											
		12	11	10	9	8	7	6	5	4	3	2	1
5 t (5.5 USt)	80 kg (176 lb)	—	—	—	—	—	—	—	—	—	—	—	5000 kg (11,000 lb)
35 t (38.5 USt) 3-sheave	270 kg (595 lb)	—	—	—	—	—	35 000 kg (77,000 lb)	30 000 kg (66,000 lb)	25 000 kg (55,000 lb)	20 000 kg (44,000 lb)	15 000 kg (33,000 lb)	10 000 kg (22,000 lb)	5000 kg (11,000 lb)
60 t (66.1 USt) 6-sheave *optional	850 kg (1874 lb)	60 000 kg (132,000 lb)	55 000 kg (121,000 lb)	50 000 kg (110,000 lb)	45 000 kg (99,000 lb)	40 000 kg (88,000 lb)	35 000 kg (77,000 lb)	30 000 kg (66,000 lb)	25 000 kg (55,000 lb)	20 000 kg (44,000 lb)	15 000 kg (33,000 lb)	10 000 kg (22,000 lb)	5000 kg (11,000 lb)

Working range

Main boom – metric 75%

Main boom

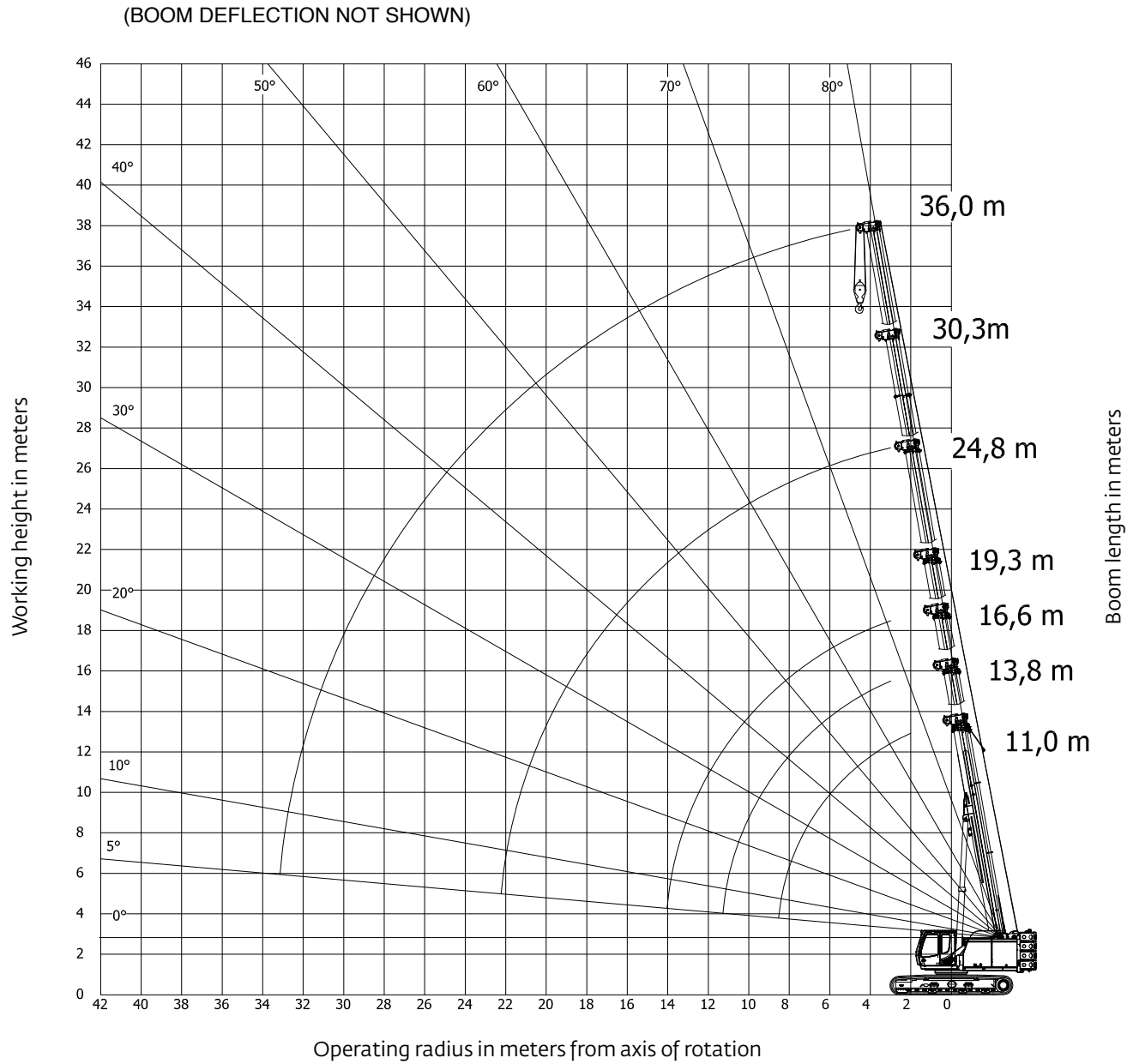

*THIS CHART IS ONLY A GUIDE AND SHOULD NOT BE USED TO OPERATE THE CRANE.
The individual crane's load chart, operating instructions and other instructional plates must be read and understood prior to operating the crane.*

Load chart

Main boom – metric 75%



36 m



17,4 t



8 t



100%



360°



Kilograms

Radius in meters	Main boom length in meters						
	11,0	13,8	16,6	19,3	24,8	30,3	36,0
2	70 000	—	—	—	—	—	—
2,5	69 500	—	—	—	—	—	—
3	67 200	61 000	44 000	37 800	22 500	—	—
4	56 000	53 600	37 700	32 600	22 500	21 000	—
5	44 900	44 500	32 900	28 500	22 500	20 100	14 500
6	37 300	36 900	29 100	25 100	22 100	18 400	14 500
7	31 400	30 800	26 100	22 500	19 800	16 900	14 200
8	25 500	25 000	23 600	20 300	17 900	15 400	13 400
9	—	20 800	20 500	18 400	16 400	14 100	12 600
10	—	17 600	17 400	16 800	15 000	12 900	11 800
12	—	—	13 100	13 000	12 800	11 000	10 200
14	—	—	—	10 200	10 700	9500	8700
16	—	—	—	8100	8600	8300	7500
18	—	—	—	—	7100	7300	6500
20	—	—	—	—	5900	6200	5800
22	—	—	—	—	—	5200	5200
24	—	—	—	—	—	4400	4700
26	—	—	—	—	—	3700	4000
28	—	—	—	—	—	—	3400
30	—	—	—	—	—	—	2800
32	—	—	—	—	—	—	2400
When 8 m extension is in stowed position, the rated loads must be reduced as follows:							
Reduction of load (kg)	770	610	510	430	340	280	20
Lifting capacities at 4° boom angle							
Boom angle	Main boom length in meters						
	11,0	13,8	16,6	19,3	24,8	30,3	36,0
4°	23 200 (8,5)	14 600 (11,3)	10 600 (14,1)	7200 (16,8)	4400 (22,3)	2500 (27,8)	300 (33,3)

NOTE: () reference radii in meters.

THIS CHART IS ONLY A GUIDE AND SHOULD NOT BE USED TO OPERATE THE CRANE.
The individual crane's load chart, operating instructions and other instructional plates must be read and understood prior to operating the crane.

Load chart

Auxiliary boom nose – metric 75%



36 m



With auxiliary boom nose



17,4 t



8 t



100%



360°



Kilograms

Radius in meters	Main boom length in meters						
	11,0	13,8	16,6	19,3	24,8	30,3	36,0
2	5000	5000	5000	5000	—	—	—
2,5	5000	5000	5000	5000	—	—	—
3	5000	5000	5000	5000	5000	—	—
4	5000	5000	5000	5000	5000	5000	—
5	5000	5000	5000	5000	5000	5000	5000
6	5000	5000	5000	5000	5000	5000	5000
7	5000	5000	5000	5000	5000	5000	5000
8	5000	5000	5000	5000	5000	5000	5000
9	—	5000	5000	5000	5000	5000	5000
10	—	5000	5000	5000	5000	5000	5000
12	—	—	5000	5000	5000	5000	5000
14	—	—	—	5000	5000	5000	5000
16	—	—	—	5000	5000	5000	5000
18	—	—	—	—	5000	5000	5000
20	—	—	—	—	5000	5000	5000
22	—	—	—	—	—	5000	4800
24	—	—	—	—	—	4300	4400
26	—	—	—	—	—	3600	3900
28	—	—	—	—	—	—	3300
30	—	—	—	—	—	—	2700
32	—	—	—	—	—	—	2300
When 8 m extension is in stowed position, the rated loads must be reduced as follows:							
Reduction of load (kg)	770	610	510	430	340	280	240
Lifting capacities at 4° boom angle							
Boom angle	Main boom length in meters						
	11,0	13,8	16,6	19,3	24,8	30,3	36,0
4°	5000 (8,5)	5000 (11,3)	5000 (14,1)	5000 (16,8)	4200 (22,3)	2400 (27,8)	300 (33,3)

NOTE: () reference radii in meters.

THIS CHART IS ONLY A GUIDE AND SHOULD NOT BE USED TO OPERATE THE CRANE.

The individual crane's load chart, operating instructions and other instructional plates must be read and understood prior to operating the crane.

Working range

Extensions – metric 75%

Main boom with extensions

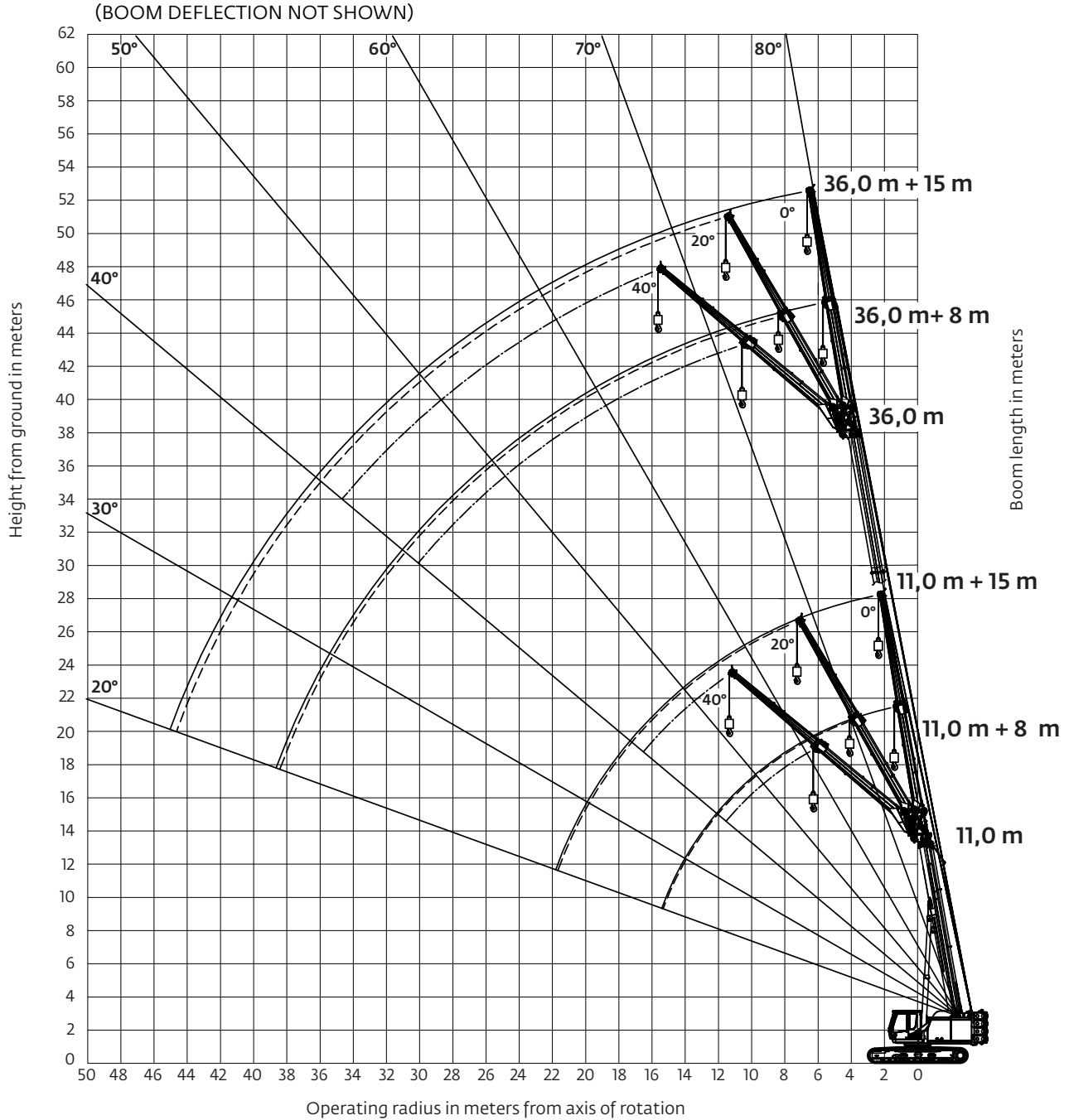

THIS CHART IS ONLY A GUIDE AND SHOULD NOT BE USED TO OPERATE THE CRANE.

The individual crane's load chart, operating instructions and other instructional plates must be read and understood prior to operating the crane.

Load chart

Extensions – metric 75%



36 m



8 m



17,4 t



8 t



100%



360°



Kilograms

Radius in meters	Main boom length in meters														
	11,0			19,3			24,8			30,3			36,0		
	0°	20°	40°	0°	20°	40°	0°	20°	40°	0°	20°	40°	0°	20°	40°
2	10 000	—	—	—	—	—	—	—	—	—	—	—	—	—	—
3	10 000	—	—	—	—	—	—	—	—	—	—	—	—	—	—
4	9700	7700	—	10 000	—	—	—	—	—	—	—	—	—	—	—
5	9200	6900	—	9600	—	—	10 000	—	—	—	—	—	—	—	—
6	9000	6700	4100	9000	5900	—	9400	—	—	8100	—	—	—	—	—
7	7700	6200	3900	8500	5600	—	8500	5800	—	8000	—	—	6400	—	—
8	7200	5900	3700	7900	5300	—	8200	5500	—	7900	5600	—	6400	—	—
9	6700	5200	3600	7300	5000	3800	7800	5200	—	7800	5400	—	6400	—	—
10	6500	5000	3500	6800	4800	3700	7400	5000	3800	7600	5200	3800	6300	5100	—
11	5500	4700	3300	6500	4400	3500	6700	4600	3600	7200	4800	3600	6100	4800	3700
12	5200	4600	3200	5500	4200	3400	6400	4400	3500	6900	4700	3600	6000	4600	3600
13	4900	4500	3100	5200	4000	3300	6000	4200	3400	6700	4500	3500	5800	4500	3500
14	4700	4400	—	4900	3800	3200	5700	4100	3400	6400	4300	3400	5600	4400	3400
15	—	4300	—	4600	3700	3200	5300	4000	3300	6100	4200	3400	5400	4200	3300
16	—	3200	—	4400	3500	3100	5100	3900	3200	5900	4100	3300	5200	4200	3300
17	—	—	—	4200	3400	3100	4900	3800	3200	5600	4000	3300	5000	4100	3300
18	—	—	—	4000	3300	3100	4600	3700	3100	5300	3900	3300	4800	4000	3200
19	—	—	—	3900	3200	3000	4400	3600	3100	5100	3800	3200	4600	3900	3200
20	—	—	—	3700	3100	—	4200	3500	3100	4900	3700	3100	4300	3800	3200
21	—	—	—	3600	3100	—	4100	3400	3000	4700	3600	3100	4200	3700	3200
22	—	—	—	3400	3100	—	3900	3300	3000	4400	3500	3100	3900	3600	3100
23	—	—	—	3200	3000	—	3800	3200	2900	4300	3500	3000	3700	3500	3100
24	—	—	—	—	—	—	3700	3100	—	4100	3400	3000	3500	3300	3100
25	—	—	—	—	—	—	3600	3100	—	3700	3300	3000	3300	3200	3100
26	—	—	—	—	—	—	3300	3100	—	3400	3300	2900	3100	3000	3100
27	—	—	—	—	—	—	3000	3000	—	3100	3200	2800	3000	2700	3000
28	—	—	—	—	—	—	2700	—	—	2700	3100	—	2900	2600	2900
29	—	—	—	—	—	—	2400	—	—	2500	2800	—	2500	2400	2800
30	—	—	—	—	—	—	—	—	—	2200	2300	—	2200	2200	2400
32	—	—	—	—	—	—	—	—	—	1900	2000	—	1900	2000	—
34	—	—	—	—	—	—	—	—	—	—	—	—	1500	1600	—
36	—	—	—	—	—	—	—	—	—	—	—	—	1200	1300	—
38	—	—	—	—	—	—	—	—	—	—	—	—	900	—	—

THIS CHART IS ONLY A GUIDE AND SHOULD NOT BE USED TO OPERATE THE CRANE.

The individual crane's load chart, operating instructions and other instructional plates must be read and understood prior to operating the crane.

Load chart

Extensions – metric 75%



36 m



15 m



17,4 t



8 t



100%



360°



Kilograms

Radius in meters	Main boom length in meters														
	11,0			19,3			24,8			30,3			36,0		
	0°	20°	40°	0°	20°	40°	0°	20°	40°	0°	20°	40°	0°	20°	40°
2	5000	—	—	—	—	—	—	—	—	—	—	—	—	—	—
3	5000	—	—	—	—	—	—	—	—	—	—	—	—	—	—
4	5000	—	—	—	—	—	—	—	—	—	—	—	—	—	—
5	4800	—	—	4600	—	—	—	—	—	—	—	—	—	—	—
6	4500	—	—	4500	—	—	4300	—	—	—	—	—	—	—	—
7	4300	3600	—	4300	—	—	4300	—	—	3900	—	—	—	—	—
8	4100	3400	—	4200	—	—	4200	—	—	3900	—	—	3400	—	—
9	4000	3200	—	4000	—	—	4100	—	—	3800	—	—	3400	—	—
10	3600	3000	—	3800	2900	—	4000	2900	—	3700	—	—	3400	—	—
11	3400	2900	2300	3700	2800	—	3900	2800	—	3700	—	—	3300	—	—
12	3300	2800	2200	3500	2700	—	3700	2800	—	3600	2800	—	3300	2700	—
13	3100	2800	2100	3400	2600	—	3600	2700	—	3500	2700	—	3300	2700	—
14	3000	2800	2000	3200	2500	2000	3500	2600	2100	3400	2600	—	3200	2600	—
15	2900	2600	1900	3000	2400	1900	3300	2500	2000	3400	2500	—	3100	2600	—
16	2800	2500	1900	2900	2300	1900	3200	2400	2000	3300	2400	2000	3100	2500	2000
17	2700	2400	1800	2800	2300	1900	3000	2300	1900	3200	2400	2000	3000	2500	2000
18	2600	2300	1800	2600	2100	1900	2900	2300	1900	3100	2300	1900	3000	2400	1900
19	2600	2200	1800	2500	2100	1900	2800	2200	1900	3000	2200	1900	2900	2400	1900
20	2500	2200	1800	2400	2000	1800	2700	2100	1800	2900	2200	1900	2800	2300	1900
21	2400	2100	1800	2300	1900	1800	2600	2100	1800	2800	2100	1900	2800	2200	1900
22	2300	2100	—	2200	1900	1700	2500	2000	1800	2700	2100	1900	2700	2200	1900
23	—	—	—	2100	1800	1600	2400	2000	1800	2600	2000	1800	2600	2100	1800
24	—	—	—	2000	1800	1600	2300	1900	1700	2500	2000	1800	2600	2100	1800
25	—	—	—	2000	1800	1600	2200	1900	1700	2500	2000	1800	2500	2000	1800
26	—	—	—	1900	1700	1600	2200	1800	1700	2400	1900	1700	2500	2000	1800
27	—	—	—	1800	1700	—	2200	1800	1700	2300	1900	1700	2400	1900	1800
28	—	—	—	1800	1700	—	2100	1800	1700	2200	1900	1700	2400	1900	1800
29	—	—	—	1700	1700	—	2100	1800	1700	2200	1900	1700	2300	1900	1800
30	—	—	—	1700	1700	—	2000	1800	1700	2100	1800	1700	2300	1800	1700
32	—	—	—	—	—	—	2000	1700	—	2000	1800	1700	2200	1800	1700
34	—	—	—	—	—	—	1900	1700	—	1900	1800	1700	1900	1700	1700
36	—	—	—	—	—	—	1700	—	—	1600	1700	—	1600	1700	1600
38	—	—	—	—	—	—	—	—	—	1300	1500	—	1300	1600	1600
40	—	—	—	—	—	—	—	—	—	1000	1200	—	1000	1300	1000
42	—	—	—	—	—	—	—	—	—	—	—	—	800	1000	—
44	—	—	—	—	—	—	—	—	—	—	—	—	600	700	—

THIS CHART IS ONLY A GUIDE AND SHOULD NOT BE USED TO OPERATE THE CRANE.

The individual crane's load chart, operating instructions and other instructional plates must be read and understood prior to operating the crane.

Working range

Main boom – imperial 75%

Main boom

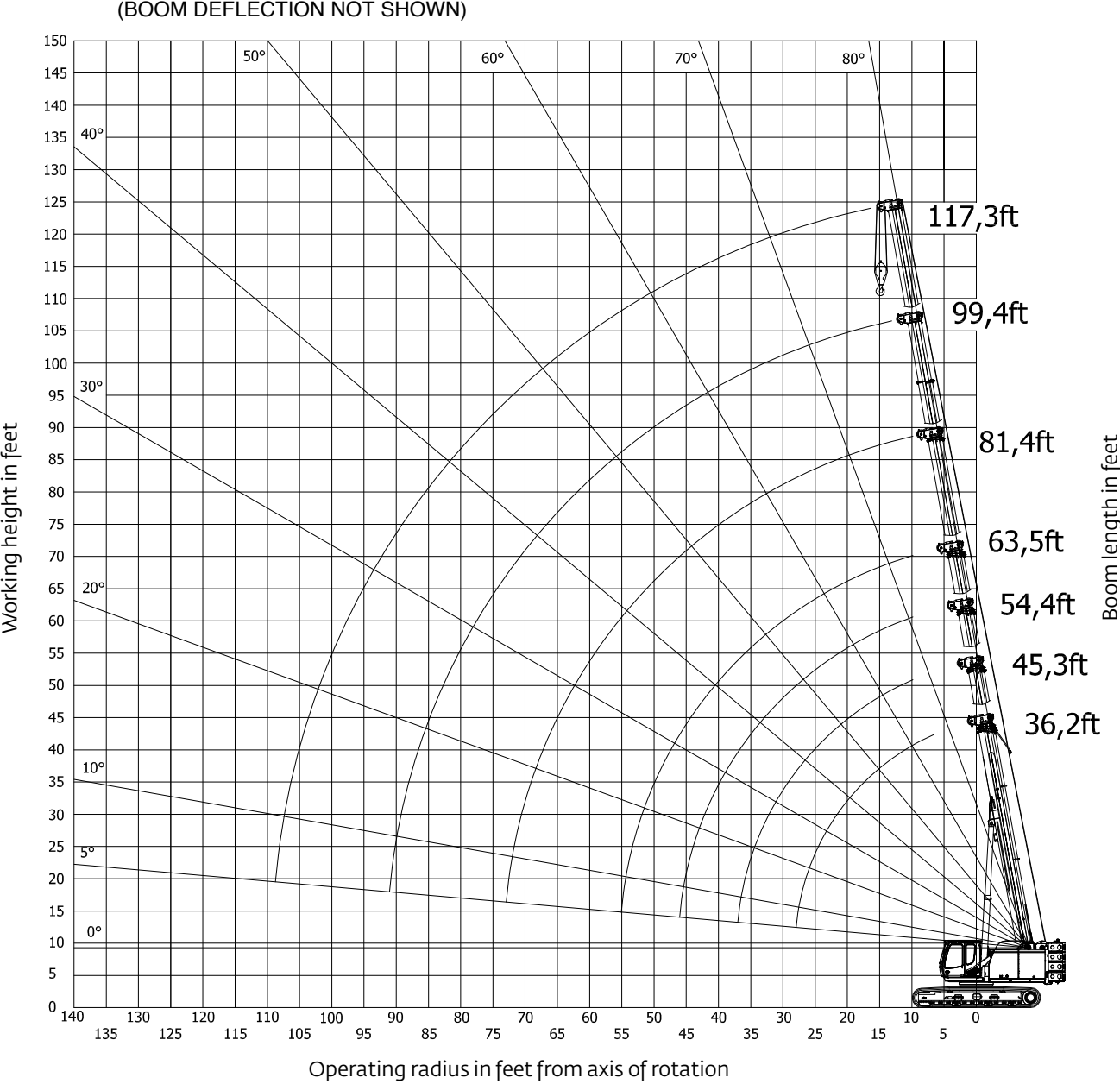

*THIS CHART IS ONLY A GUIDE AND SHOULD NOT BE USED TO OPERATE THE CRANE.
The individual crane's load chart, operating instructions and other instructional plates must be read and understood prior to operating the crane.*

Load chart

Main boom – imperial 75%



117.3 ft



38,450 lb



17,637 lb



100%



360°

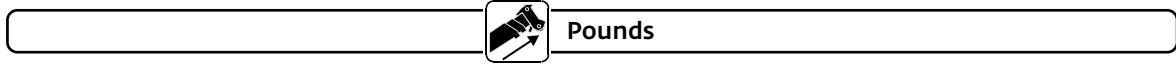

Radius in feet	Main boom length in feet						
	36.2	45.3	54.4	63.5	81.4	99.4	117.3
7	150,000	—	—	—	—	—	—
10	147,100	133,800	96,400	82,900	49,600	—	—
15	109,500	106,800	77,100	66,800	49,600	45,200	—
20	81,000	80,100	63,600	54,800	48,300	40,300	31,900
25	61,200	60,000	54,200	46,600	41,100	35,200	30,200
30	—	44,900	44,200	40,100	35,700	30,700	27,500
35	—	35,300	34,900	34,300	31,300	27,000	24,700
40	—	—	28,200	28,000	27,700	23,900	22,200
45	—	—	—	23,300	24,200	21,400	19,600
50	—	—	—	19,600	20,700	19,300	17,600
55	—	—	—	—	17,700	17,500	15,700
60	—	—	—	—	15,300	15,800	14,100
65	—	—	—	—	13,300	13,900	12,900
70	—	—	—	—	—	12,200	11,900
75	—	—	—	—	—	10,700	11,000
80	—	—	—	—	—	9400	10,100
85	—	—	—	—	—	8200	8900
90	—	—	—	—	—	—	7900
95	—	—	—	—	—	—	6900
100	—	—	—	—	—	—	6000
105	—	—	—	—	—	—	5300
When 26.2' extension is in stowed position, the rated loads must be reduced as follows:							
Reduction of load (lb)	1101	887	745	638	506	423	372
Lifting capacities at 4° boom angle							
Boom Angle	Main boom length in feet						
	36.2	45.3	54.4	63.5	81.4	99.4	117.3
4°	51,100 (27.9)	32,200 (37.1)	23,400 (46.3)	15,900 (55.1)	9700 (73.2)	5500 (91.2)	700 (109.3)

NOTE: () reference radii in meters.

THIS CHART IS ONLY A GUIDE AND SHOULD NOT BE USED TO OPERATE THE CRANE.
The individual crane's load chart, operating instructions and other instructional plates must be read and understood prior to operating the crane.

Load chart

Auxiliary boom nose – imperial 75%



117.3 ft



With auxiliary boom nose



38,450 lb



17,637 lb



360°



100%

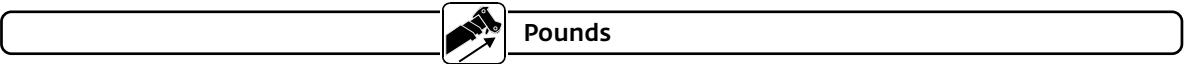

Radius in feet	Main boom length in feet						
	36.2	45.3	54.4	63.5	81.4	99.4	117.3
7	11,000	—	—	—	—	—	—
10	11,000	11,000	11,000	11,000	11,000	—	—
15	11,000	11,000	11,000	11,000	11,000	11,000	—
20	11,000	11,000	11,000	11,000	11,000	11,000	11,000
25	11,000	11,000	11,000	11,000	11,000	11,000	11,000
30	—	11,000	11,000	11,000	11,000	11,000	11,000
35	—	11,000	11,000	11,000	11,000	11,000	11,000
40	—	—	11,000	11,000	11,000	11,000	11,000
45	—	—	—	11,000	11,000	11,000	11,000
50	—	—	—	11,000	11,000	11,000	11,000
55	—	—	—	—	11,000	11,000	11,000
60	—	—	—	—	11,000	11,000	11,000
65	—	—	—	—	11,000	11,000	11,000
70	—	—	—	—	—	11,000	10,900
75	—	—	—	—	—	10,400	10,200
80	—	—	—	—	—	9200	9500
85	—	—	—	—	—	8000	8700
90	—	—	—	—	—	—	7700
95	—	—	—	—	—	—	6600
100	—	—	—	—	—	—	5700
105	—	—	—	—	—	—	5100
When 26.2' extension is in stowed position, the rated loads must be reduced as follows:							
Reduction of load (lb)	1,101	887	745	638	506	423	372
Lifting capacities at 4° boom angle							
Boom Angle	Main boom length in feet						
	36.2	45.3	54.4	63.5	81.4	99.4	117.3
4°	11,000 (27.9)	11,000 (37.1)	11,000 (46.3)	11,000 (55.1)	9300 (73.2)	5300 (91.2)	700 (109.3)

NOTE: () reference radii in meters.

THIS CHART IS ONLY A GUIDE AND SHOULD NOT BE USED TO OPERATE THE CRANE.
The individual crane's load chart, operating instructions and other instructional plates must be read and understood prior to operating the crane.

Working range

Extensions – imperial 75%

Main boom with extensions

(BOOM DEFLECTION NOT SHOWN)

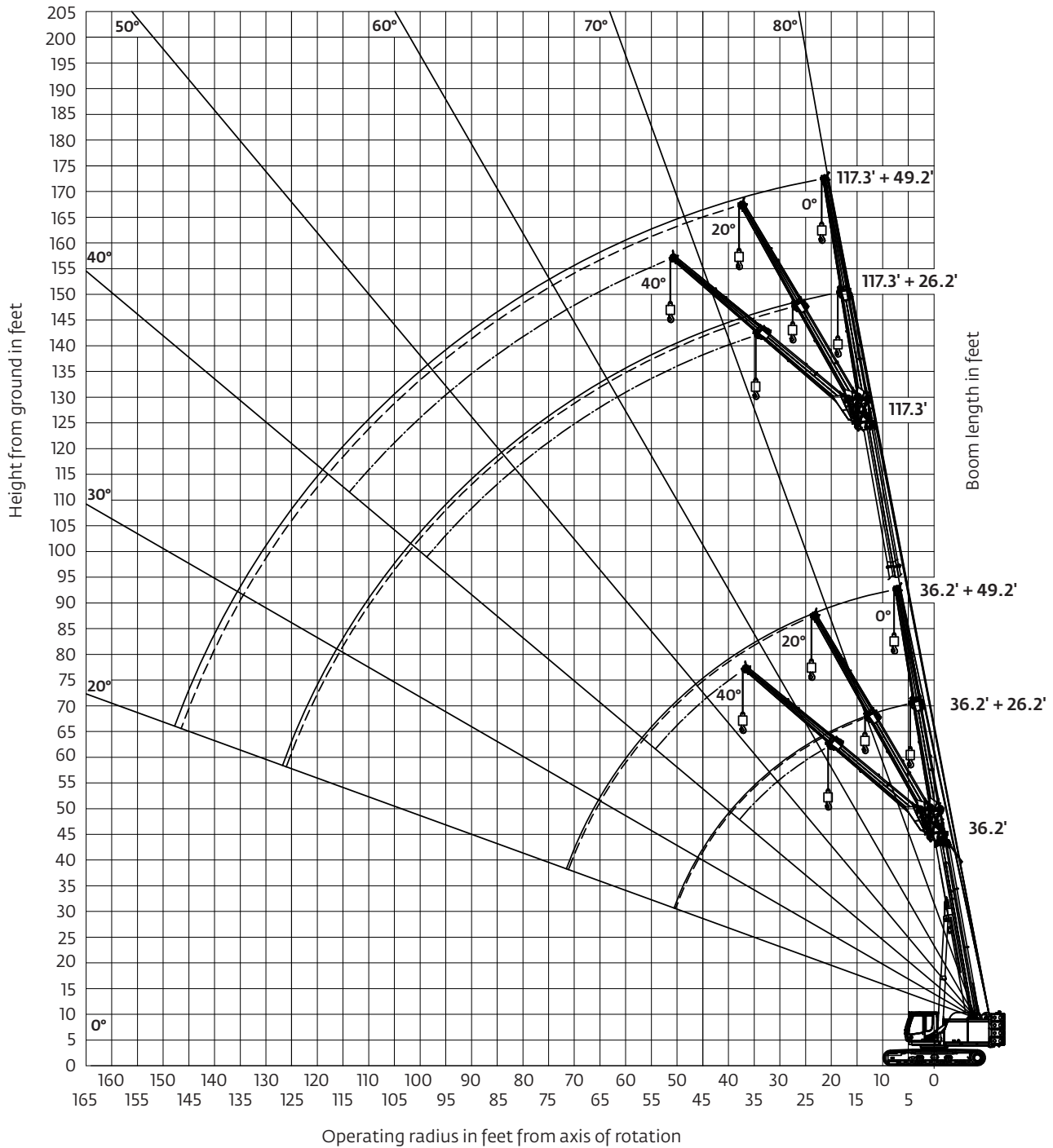

THIS CHART IS ONLY A GUIDE AND SHOULD NOT BE USED TO OPERATE THE CRANE.

The individual crane's load chart, operating instructions and other instructional plates must be read and understood prior to operating the crane.

Load chart

Extensions – imperial 75%



117.3 ft



26 ft 3 in



38,450 lb



17,637 lb



100%



360°



Pounds

Radius in feet	Main boom length in feet														
	36.2			63.5			81.4			99.4			117.3		
	0°	20°	40°	0°	20°	40°	0°	20°	40°	0°	20°	40°	0°	20°	40°
10	22,000	—	—	—	—	—	—	—	—	—	—	—	—	—	—
15	20,800	16,000	—	21,600	—	—	—	—	—	—	—	—	—	—	—
20	19,600	14,700	9000	19,800	13,000	—	20,500	—	—	17,900	—	—	—	—	—
25	16,300	13,300	8300	17,900	11,900	—	18,300	12,400	—	17,500	—	—	14,100	—	—
30	14,700	11,400	7900	15,900	11,000	8400	17,100	11,400	—	17,100	11,900	—	14,100	—	—
35	12,900	10,600	7400	14,600	10,000	7900	15,300	10,400	8100	16,200	10,900	8100	13,600	10,800	—
40	11,300	10,100	7000	12,000	9200	7500	14,000	9600	7700	15,100	10,300	7900	13,200	10,100	7900
45	10,500	9800	—	11,000	8500	7100	12,800	9100	7500	14,300	9600	7600	12,500	9800	7600
50	—	8900	—	10,000	8100	7000	11,600	8800	7200	13,400	9200	7400	11,800	9300	7300
55	—	—	—	9400	7600	6800	10,900	8400	7100	12,500	8900	7300	11,100	9100	7300
60	—	—	—	8800	7200	6800	10000	8100	6800	11,600	8500	7200	10 500	8800	7200
65	—	—	—	8200	6900	—	9300	7800	6800	10,900	8200	6900	9600	8400	7100
70	—	—	—	7800	6800	—	9000	7400	6600	10,100	7900	6800	9000	8100	7000
75	—	—	—	7100	6700	—	8600	7100	6400	9500	7700	6700	8200	7800	6800
80	—	—	—	—	—	—	8300	6800	—	8700	7400	6600	7600	7200	6800
85	—	—	—	—	—	—	8000	6800	—	8000	7300	6400	6900	6700	6800
90	—	—	—	—	—	—	7200	—	—	7100	7000	—	6400	5900	6500
95	—	—	—	—	—	—	6200	—	—	6400	6200	—	5500	5300	6200
100	—	—	—	—	—	—	—	—	—	5500	4900	—	4700	4700	—
105	—	—	—	—	—	—	—	—	—	4900	—	—	4400	4400	—
110	—	—	—	—	—	—	—	—	—	4200	—	—	3900	4100	—
115	—	—	—	—	—	—	—	—	—	—	—	—	3500	3700	—
120	—	—	—	—	—	—	—	—	—	—	—	—	3200	—	—

THIS CHART IS ONLY A GUIDE AND SHOULD NOT BE USED TO OPERATE THE CRANE.

The individual crane's load chart, operating instructions and other instructional plates must be read and understood prior to operating the crane.

Load chart

Extensions - imperial 75%



117.3 ft



49 ft 3 in



38,450 lb



17,637 lb



100%



360°

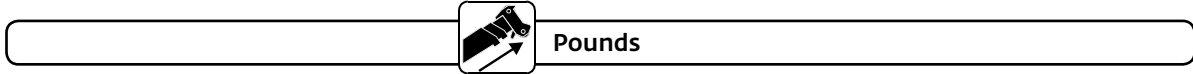

Radius in feet	Main boom length in feet														
	36.2			63.5			81.4			99.4			117.3		
	0°	20°	40°	0°	20°	40°	0°	20°	40°	0°	20°	40°	0°	20°	40°
15	10,800	—	—	—	—	—	—	—	—	—	—	—	—	—	—
20	9900	—	—	9500	—	—	9500	—	—	—	—	—	—	—	—
25	9200	7700	—	9400	—	—	9400	—	—	8600	—	—	—	—	—
30	8700	7000	—	9000	6400	—	9000	—	—	8400	—	—	7500	—	—
35	7600	6500	—	8700	6300	—	8700	6300	—	8200	—	—	7400	—	—
40	7200	6200	4800	8100	5900	—	8100	6100	—	7900	6100	—	7300	6000	—
45	6700	6200	4500	7800	5600	—	7800	5800	—	7600	5800	—	7100	5800	—
50	6300	5700	4200	7200	5200	4200	7200	5500	4400	7400	5500	—	6800	5700	—
55	6000	5300	4000	6700	5100	4200	6700	5100	4200	7100	5300	4400	6700	5500	4400
60	5700	5000	4000	6300	4600	4200	6300	5000	4200	6800	5000	4200	6600	5300	4200
65	5600	4900	4000	6000	4500	4000	6000	4700	4000	6400	4900	4200	6200	5100	4200
70	5200	4600	—	5700	4200	3900	5700	4600	4000	6100	4600	4200	6100	4900	4200
75	—	—	—	5300	4000	3600	5300	4400	4000	5800	4400	4000	5800	4700	4000
80	—	—	—	5000	4000	3500	5000	4200	3800	5500	4400	4000	5700	4500	4000
85	—	—	—	4900	3800	3300	4900	4000	3800	5300	4200	3800	5500	4400	4000
90	—	—	—	4800	3800	—	4800	4000	3800	5000	4200	3800	5300	4200	4000
95	—	—	—	4600	3800	—	4600	4000	3800	4900	4200	3800	5100	4200	4000
100	—	—	—	4400	—	—	4400	3900	—	4600	4000	3800	5000	4000	3800
105	—	—	—	4400	—	—	4400	3800	—	4400	4000	3800	4900	4000	3800
110	—	—	—	4200	—	—	4200	3800	—	4200	4000	3800	4300	3800	3800
115	—	—	—	—	—	—	—	—	—	3800	3900	—	4000	3800	3600
120	—	—	—	—	—	—	—	—	—	3500	3700	—	3600	3700	3500
125	—	—	—	—	—	—	—	—	—	3300	3500	—	3300	3500	—
130	—	—	—	—	—	—	—	—	—	3100	3400	—	3100	3400	—
135	—	—	—	—	—	—	—	—	—	—	—	—	3000	3200	—
140	—	—	—	—	—	—	—	—	—	—	—	—	2800	2900	—

THIS CHART IS ONLY A GUIDE AND SHOULD NOT BE USED TO OPERATE THE CRANE.
The individual crane's load chart, operating instructions and other instructional plates must be read and understood prior to operating the crane.

Load handling

Weight reductions for load handling devices		
8 m - 15 m (26.2 ft - 49.2 ft) Boom extension:		
	Without block or ball	With 80 kg (176 lb) headache ball
*8 m (26.2 ft) extension (erected)	1295 kg (2416 lb)	1240 kg (2736 lb)
*15 m (49.2 ft) extension (erected)	1755 kg (3871 lb)	1953 kg (4305 lb)
Hook blocks and Headache ball:		
60 t (66 USt), 6 sheave		850 kg+ (1875 lb+)
35 t (38.5 USt), 3 sheave		270 kg+ (595 lb+)
5 t (5.5 USt) headache ball		80 kg+ (176 lb+)

*Reduction of main boom capacities
+Refer to rating plate for actual weight

When lifting over swingaway and/or jib combinations, deduct total weight of all load handling devices reeved over main boom nose directly from swingaway or jib capacity.

NOTE: All load handling devices and boom attachments are considered part of the load and suitable allowances **MUST BE MADE** for their combined weights. Weights are for Grove furnished equipment.

Line pulls and reeving information			
Hoists	Cable specs	Permissible line pulls	Nominal cable length
Main and auxiliary	16 mm (5/8") Verotop Rotation Resistant (non-rotating) Min. breaking strength 24 900 kg (54,895 lb)	5000 kg (11,000 lb*)	205 m (672 ft)
Main and auxiliary	6 mm (5/8") 35x7 Class Rotation Resistant (non-rotating) Min. breaking strength 27 760 kg (61,200 lb)	5000 kg (11,000 lb*)	205 m (672 ft)

The approximate weight of Verotop 16 mm (5/8") wire rope is 1,25 kg/m (0.84 lb/ft).
The approximate weight of 35x7 class 16 mm (5/8") wire rope is 1,5 kg/m (1.0 lb/ft).

*With certain boom and hoist tackle combinations, the allowable line pull may be limited by hoist performance. Refer to Hoist Performance table for lift planning to ensure adequate hoist performance on drum rope layer required.

Hoist performance			
Wire rope layer	Hoist line pulls	Drum rope capacity	
		Available*	Total
1	7678 kg (16,928 lb)	26,5 m (86.8 ft)	26,5 m (86.8 ft)
2	7204 kg (15,883 lb)	28,2 m (92.5 ft)	54,7 m (179.3 ft)
3	6785 kg (14,959 lb)	29,9 m (98.2 ft)	84,6 m (277.5 ft)
4	6412 kg (14,137 lb)	31,7 m (103.9 ft)	116,3 m (381.4 ft)
5	6078 kg (13,400 lb)	33,4 m (109.7 ft)	149,7 m (491.1 ft)
6	5777 kg (12,736 lb)	35,1 m (115.3 ft)	184,8 m (606.4 ft)
7	5504 kg (12,135 lb)	36,9 m (121.1 ft)	221,7 m (727.5 ft)

*Max lifting capacity: Verotop and 35x7 class rope = 5000 kg (11,000 lb)

Working area diagram

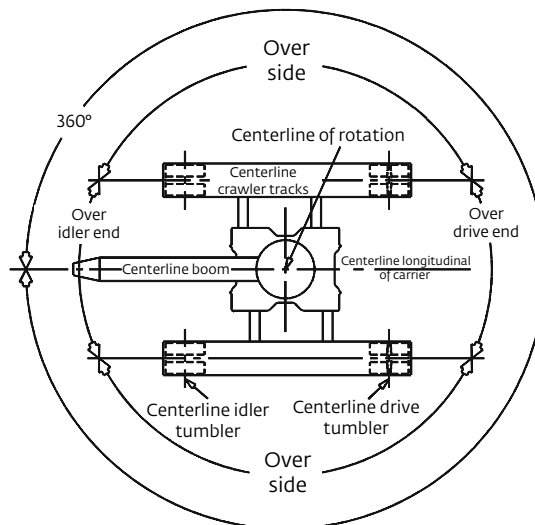

THIS CHART IS ONLY A GUIDE AND SHOULD NOT BE USED TO OPERATE THE CRANE.

The individual crane's load chart, operating instructions and other instructional plates must be read and understood prior to operating the crane.

Specifications

Upper carriage



Boom

11 m – 36 m (36 ft – 118 ft 1 in) four-section, full power, sequenced-synchronized, telescopic boom.

Maximum tip height: 38 m (125 ft)



Boom extension

8 m (26 ft 3 in) offsettable, solid, one piece swingaway extension. Extension can be offset at 0°, 20° and 40°.

Maximum tip height: 46 m (151 ft)



*Optional boom extension

7 m (23 ft) offsettable fly jib extension that must be used in conjunction with standard 8 m (26 ft 3 in) boom extension. This provides a total of 15 m (49 ft 3 in) of additional reach. The optional fly jib extension can not be stowed on boom.

Maximum tip height: 52,7 m (173 ft)

Boom extension can be offset 0°, 20°, and 40°.



Boom nose

Seven nylon sheaves on heavy-duty roller bearings with removable rope guards. Quick reeve type boom nose.

Equipped with removable auxiliary boom nose.



Boom elevation

One double-acting hydraulic cylinder with integral holding valves. Elevation: -3° to 81°



Rated capacity limiter and anti-two block system

Graphical display of load moment and anti-two block system with audio-visual warning and control lever lockout. These systems provide electronic display of crane configuration, boom angle, length, radius, tip height, maximum permissible load, momentary load and warning of impending two-block condition. Includes advanced diagnostics system that increases the performance of the machine, simplifies and accelerates troubleshooting, and lowers operating costs. Equipped with event recorder.



Counterweight

Upper weight: 17 440 kg (38,450 lb) total (5 pieces)

Carbody weight: 8000 kg (17,637 lb) total (2 pieces)



Cab

Large-capacity operator's compartment that includes an air suspended operator's seat with lumbar support, heated seat, headrest, 3 inch safety belt, ergonomic control panels, load sensing electric dual axis joystick controls, travel pedals and levers, exceptional sound insulation, sliding door (includes sliding window), excellent all around visibility, tinted safety glass, front tiltable window, large skylight w/ sun protection, windshield and roof wiper/washer system, radio w/ CD player, climate control (A/C, heat, and defrost), fire extinguisher, and 20° tilt capability for improved overhead vision and ergonomic posture. Also equipped with a 7 inch monitor in cab for rear view, right side and hoist cameras.



Swing

Two-speed, compact planetary gear with slant axis hydraulic motor and integrated brake valves. Sealed, externally geared slewing ring that allows for 360° of continuous rotation.

Electronically applied service brake operated via foot pedal. Spring applied, hydraulically released parking brake. One position, hydraulically pinned house lock.

Swing speed: 0-2 rpm, variable



Hydraulic system

Load sensing / LUDV hydraulic system with hydraulic and pilot controlled work functions, and load limit sensing control. Single variable-displacement piston pump with a three section gear pump.

Maximum output: 375 lpm (99 gpm)

Maximum operating pressure: 330 bar (4786 psi)

765 L (202 gal) steel hydraulic reservoir with sight level gauge.

High performance, 3 micron filtration system with water absorption contamination indicator for higher oil purity and extended oil service life.



Hoist (main and auxiliary hoist)

Single-speed hoists driven via a slant axis hydraulic motor with compact planetary gear. Spring-loaded disc brake. Grooved drum with drum rotation indicator for both hoists that is located in the joystick controls.

Maximum hoist pull (first layer): 7678 kg (16,928 lb)

Maximum permissible single line pull: 4990 kg (11,000 lb)

Maximum single line speed: 115 m/min (380 ft/min)

Rope construction: 35 X 7 Rotation Resistant

Rope diameter: 16 mm (5/8 in)

Rope length: 205 m (673 ft)



Engine (Tier 4)

Cummins QSB 6.7 L diesel, six cylinders, turbocharged with Cummins Diesel Oxidation Catalyst (DOC) exhaust and Selective Catalytic Reduction (SCR).

Meets USEPA Tier 4 final requirements.

168 kW (228 bhp) at 2000 rpm.

Fuel requirements: Maximum of 15 ppm sulphur content (ultra-low diesel fuel). DEF (diesel exhaust fluid) required for SCR (selective catalytic reduction).

NOTE: Tier 4 engine required for sale in North America.



Engine (Tier 3)

Cummins QSB 6.7 L diesel, six cylinders, turbocharged rated at 164 kW (223 bhp) at 2000 rpm.

NOTE: Required for sale outside of North America.



Fuel tank capacity

Diesel Fuel: 540 L (143 gal)

DEF (Diesel Exhaust Fluid): 38 L (10 gal)



Electrical system

24 volt with two 12-volt, maintenance-free batteries. Includes battery disconnect switch.



Lights

Lighting package includes two halogen lights integrated into the front side of the cab roof and one LED headlight on the upper carriage, right side.

Lower Carriage



Frame

Durable all steel welded construction with extendable axles.



Side frames

Four steel side frame beams that can be hydraulically extended or retracted via controls in the cab. 900 mm (36 in) triple bar maintenance-free track shoes.

Retracted gauge (transportation only): 2,3 m (7 ft 6 in)

Intermediate gauge: 3,2 m (10 ft 6 in)

Extended gauge: 4,1 m (13 ft 6 in)

*Note: These widths are from centerline to centerline of crawlers.



Travel

Two-speed hydrostatic drive operated via lever/pedal controls in cab. Allows for excellent maneuverability with skid steering and counter-rotation. Both side frames are hydraulically driven through a two-stage hydraulic traction motor. Spring-loaded, hydraulically venting disk brake.

Travel Speed: Max Low Range – 0,93 kmh (0.58 mph)

Max High Range – 2,7 kmh (1.68 mph)

Gradeability (theoretical): 64%

Operating weight

71 760 kg (158,200 lb) base machine configuration that includes 36 m (118 ft 1 in) boom, 8 m (26 ft 3 in) extension, 35 t (38.5 USt) hook block, 900 mm (36 in) triple bar shoes, main and auxiliary hoist, 17 440 kg (38,450 lb) counterweight and 8000 kg (17,637 lb) carbody.

Ground bearing pressure (no load): .77 kg/cm² (10.95 psi)

Miscellaneous standard equipment

- Central, easily accessible lubricating strip for slewing ring.
- Grated platform in front of cab, and foldable grated platforms on side of cab and both sides of the upper carriage. Foldable handrails included for upper carriage.
- Storage box attached to the rear carbody weight.
- Service friendly engine and hydraulic compartments with decoupled engine suspension, sound proofing, and lighting.
- 35 t (38.5 USt) 3-sheave, quick reeve hook block.
- External RCL light bar.
- CraneStar asset management system.

* Optional equipment

- Auger Ready Package: Includes hoses and pipes at the base boom, auger hydraulic circuit 150 L/min (39 gpm), 175 bar (2500 psi), controls and switches in the cab for auger operation.
- Auger Motor and Kelly Bar: includes stowage brackets, hydraulic hoses to connect to the auger ready package

- plumbing, the auger motor and Kelly bar.
- Auger Flightings: 609 mm (24 in), 914 mm (36 in) and 1219 mm (48 in) available.
- Pole Claw Preparation / Tool Circuit: Provides 35 L/min (9 gpm), 175 bar (2500 psi) through a 32 m (105 ft) hose reel with quick disconnect fittings, switch for tilting and clamping function, controls and switches in the cab.
- Pole grabber.
- Basket: Yoke style, 1829 mm x 914 mm (72 in x 36 in) steel basket, gravity hung with cylinder brake lock (does not side stow). Includes quick-attach boom attachment. Basket capacities: 544,3 kg (1200 lb) main boom and 226,7 kg (500 lb) on boom extension.
- Radio remote control package.
- Cold weather packages up to -40° C / -40° F.
- Swing barrier protection.
- Maintenance-free flat track shoes.
- Polyurethane clamp-on track pads.

Symbols Glossary



Boom



Drive



Heavy duty jib



Speed



Boom elevation



Electrical system



Hoist



Steering



Boom extension



Engine



Hook block



Suspension



Boom length



Extension



Hydraulic system



Swing



Brakes



Frame



Lights



Tires



Cab



Fuel tank capacity



Oil



Transmission



Crawler



Outriggers



Outrigger controls



Crawler



Gear



Radius



Counterweight



Grade



Rotation

Notes

Manitowoc Cranes

Regional headquarters

Americas

Manitowoc, Wisconsin, USA

Tel: +1 920 684 6621

Fax: +1 920 683 6277

Shady Grove, Pennsylvania, USA

Tel: +1 717 597 8121

Fax: +1 717 597 4062

Europe, Middle East, Africa

Dardilly, France

Tel: +33 (0)4 72 18 20 20

Fax: +33 (0)4 72 18 20 00

China

Shanghai, China

Tel: +86 21 6457 0066

Fax: +86 21 6457 4955

Greater Asia-Pacific

Singapore

Tel: +65 6264 1188

Fax: +65 6862 4040



Manitowoc Crane Care when you need it.

The assurance of the world's most advanced crane service and support to get you back to work fast.



Manitowoc Finance helps you get right to work generating profits for your business.

Financial tools that help you capitalize on opportunity with solutions that fit your needs.

This document is non-contractual. Constant improvement and engineering progress make it necessary that we reserve the right to make specification, equipment, and price changes without notice. Illustrations shown may include optional equipment and accessories and may not include all standard equipment.