

KOMATSU®

PC490LC-11

Tier 4 Final Engine

HYDRAULIC EXCAVATOR



Photos may include optional equipment.

PC490LC

NET HORSEPOWER

359 HP @ 1900 rpm
268 kW @ 1900 rpm

OPERATING WEIGHT

105,670–110,220 lb
47,930–49,995 kg

BUCKET CAPACITY

1.47–4.15 yd³
1.12–3.17 m³

WALK-AROUND

PC490LCG-11



Photos may include optional equipment.

NET HORSEPOWER
359 HP @ 1900 rpm
268 kW @ 1900 rpm

OPERATING WEIGHT
105,670–110,220 lb
47,930–49,995 kg

BUCKET CAPACITY
1.47–4.15 yd³
1.12–3.17 m³



PERFORMANCE, DURABILITY AND FUEL ECONOMY

A large machine design with a reinforced undercarriage provides high lift capacity, lateral stability and added durability.

Enhanced Power Mode with increased hydraulic flow and new Tier 4 Final engine technology improves performance and fuel efficiency.

A powerful **Komatsu SAA6D125E-7 engine** provides a net output of 268 kW **359 HP**. This engine is EPA Tier 4 Final emissions certified.

Komatsu Variable Geometry Turbocharger (KVG T) uses a hydraulic actuator to provide optimum air flow under all speed and load conditions.

Komatsu Diesel Particulate Filter (KDPF) and Selective Catalytic Reduction (SCR) system reduce particulate matter and NOx while providing automatic regeneration that does not interfere with daily operation.

Large displacement high efficiency pumps provide high flow output at lower engine speed, improving efficiency.

Two boom mode settings provide power mode for maximum digging force or smooth mode for fine grading operations.

Komatsu's Closed-center Load Sensing System (CLSS) provides quick response and smooth operation to maximize productivity.

KOMTRAX® equipped machines can send location, SMR and operation maps to a secure website or smart phone utilizing wireless technology. Machines also relay error codes, cautions, maintenance items, fuel & Diesel Exhaust Fluid (DEF) levels, and much more.

Large LCD color monitor panel:

- 7" high resolution screen
- Provides "Ecology-Guidance" for fuel efficient operation
- Enhanced attachment control

Rearview monitoring system (standard)

Six working modes are designed to match engine speed, pump delivery, and system pressure to the application. An enhanced power mode is available to provide improved performance in high production applications.



Enhanced working environment

- High back, heated air suspension operator seat with adjustable arm rests
- Integrated ROPS cab design
- Cab meets ISO Level 1 Operator Protective Guard (OPG) top guard
- Standard pattern change valve to switch from ISO to BH control pattern
- Aux jack and (2) 12V power outlets

Komatsu designed and manufactured components

Hydraulically driven variable speed fan is temperature controlled to reduce parasitic load on the engine to improve fuel consumption and can be manually reversed to simplify cooler maintenance.

Guardrails (standard) located on the machine upper structure provide a convenient work area in front of the engine.

Battery disconnect switch allows a technician to disconnect the power supply before servicing the machine.

Heavy duty boom design with large one piece castings provides increased strength and durability.

Komatsu Auto Idle Shutdown helps reduce nonproductive engine idle time and reduces operating costs.

Operator Identification System can track machine operation for more than 25 operators.

PERFORMANCE FEATURES

KOMATSU NEW ENGINE TECHNOLOGIES

New Tier 4 Final Engine

The Komatsu SAA6D125E-7 engine is EPA Tier 4 Final emissions certified and provides exceptional performance while reducing fuel consumption. Based on Komatsu proprietary technologies developed over many years, this new diesel engine reduces nitrogen oxides (NOx) by more than 80% when compared to Tier 4 interim levels. Through the in-house development and production of engines, electronics, and hydraulic components, Komatsu has achieved great advancements in technology, providing high levels of performance and efficiency in virtually all applications.

Technologies Applied to New Engine

Heavy-duty aftertreatment system

This new system combines a Komatsu Diesel Particulate Filter (KDPF) and Selective Catalytic Reduction (SCR). The SCR NOx reduction system injects the correct amount of Diesel Exhaust Fluid (DEF) at the proper rate, thereby decomposing NOx into non-toxic water vapor (H₂O) and nitrogen gas (N₂).

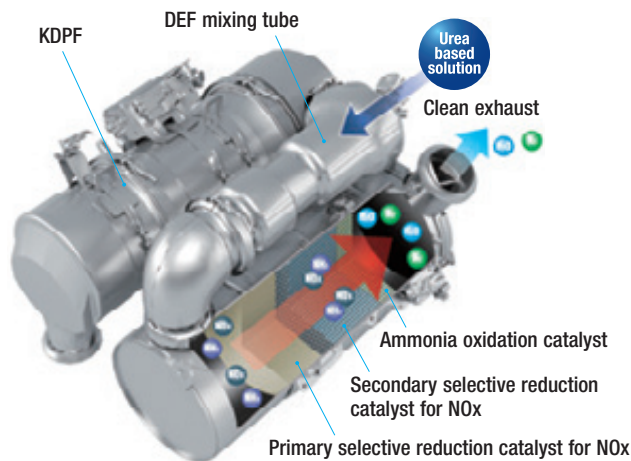

Heavy-duty cooled Exhaust Gas Recirculation (EGR) system

The system recirculates a portion of exhaust gas into the air intake and lowers combustion temperatures, thereby reducing NOx emissions. EGR gas flow has been decreased for Tier 4 Final with the addition of SCR technology. The system achieves a dynamic reduction of NOx, while helping reduce fuel consumption below Tier 4 Interim levels.

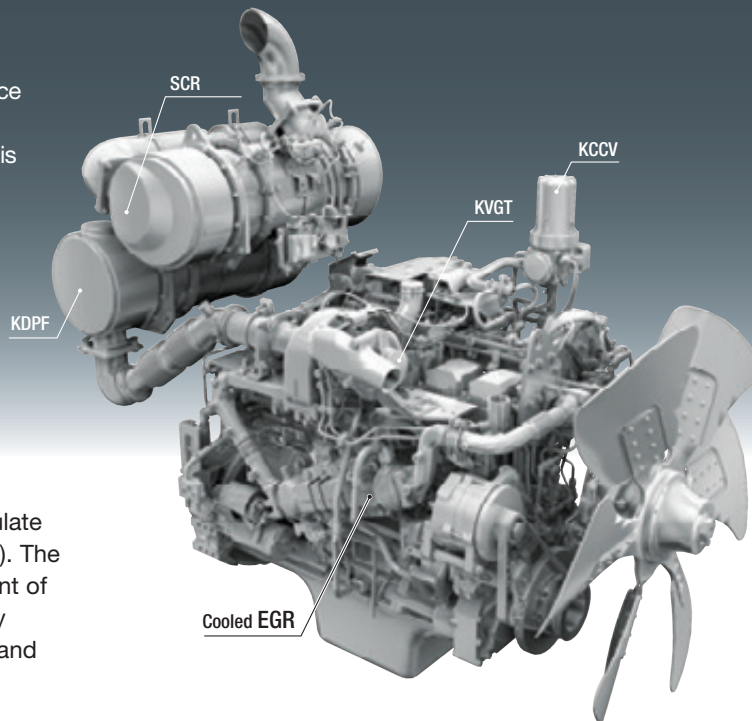
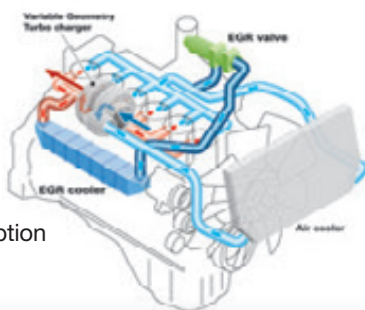

Advanced Electronic Control System

The electronic control system performs high-speed processing of all signals from sensors installed in the vehicle providing total control of equipment in all conditions of use. Engine condition information is displayed via an on-board network to the monitor inside the cab, providing necessary information to the operator. Additionally, managing the information via KOMTRAX helps customers keep up with required maintenance.

Komatsu Variable Geometry Turbocharger (KVGT) system

The KVGT system features proven Komatsu design hydraulic technology for variable control of air-flow and supplies optimal air according to load conditions. The upgraded version provides better exhaust temperature management.

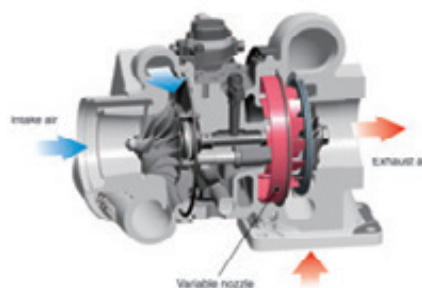

Komatsu Auto Idle Shutdown

Komatsu auto idle shutdown automatically shuts the engine down after idling for a set period of time to reduce unnecessary fuel consumption and exhaust emissions. The amount of time before the engine is shutdown can be easily programmed from 5 to 60 minutes.



Heavy-Duty High-Pressure Common Rail (HPCR) Fuel Injection System

The system is designed to achieve an optimal injection of high-pressure fuel by means of computerized control, providing close to complete combustion to reduce PM emissions. While this technology is already used in current engines, the new system uses high pressure injection, thereby reducing both PM emissions and fuel consumption over the entire range of engine operating conditions. The Tier 4 Final engine has advanced fuel injection timing for reduced fuel consumption and lower soot levels.

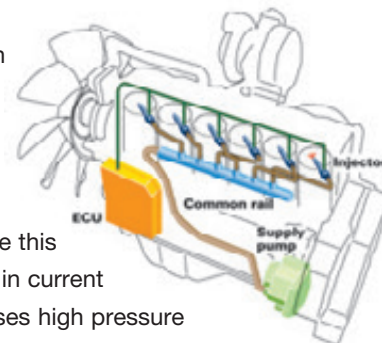

PERFORMANCE FEATURES

Enhanced Productivity

The PC490LC-11's enhanced P Mode provides more hydraulic flow and increases productivity.

Productivity

Up to 13% increase

(compared to the PC490LC-10 in standard P Mode)

P mode (90° swing and loading onto truck)

- | | |
|------------------------------------|---------------------------------|
| 1 Large counterweight | 6 Reinforced center frame |
| 2 High capacity swing bearing | 7 HD carrier rollers and idlers |
| 3 Reinforced track links and shoes | 8 Reinforced crawler frames |
| 4 Large final drive | 9 Reinforced revolving frame |
| 5 HD sprockets | 10 Track roller guards |
| | 11 Deck guard |
| | 12 Center frame swivel guard |

Increased Work Efficiency

Large digging force

With the one-touch Power Max. function digging force has been further increased. (8.5 seconds of operation)

Maximum arm crowd force (ISO)

200 kN(20.4t) ➔ **214 kN(21.8t) 7% UP**
(with Power Max.)

Maximum bucket digging force (ISO)

256 kN(26.1t) ➔ **275 kN(28.0t) 7% UP**
(with Power Max.)

Measured with Power Max. function, 3380 mm arm and ISO rating

Faster arm cycle speeds

Two return hoses improve arm cylinder hydraulic flow for faster arm out performance.

Two boom mode settings for boom function

- Smooth boom mode provides easy operation for gathering material or scraping down.
- Power boom mode maximizes digging force for more effective excavating.



PC490LC-11

Hydraulic Variable Speed Fan

The electronic control system sets the rotation speed of the cooling fan according to the coolant, hydraulic oil, and ambient temperatures; effectively uses the engine output to reduce wasteful fuel consumption; and reduces noise during low-speed fan operation.



Variable Track Gauge (option)

Lateral stability is significantly increased when operating with the gauge extended (compared to fixed gauge). With track frames retracted, overall width complies with many local transportation regulations.

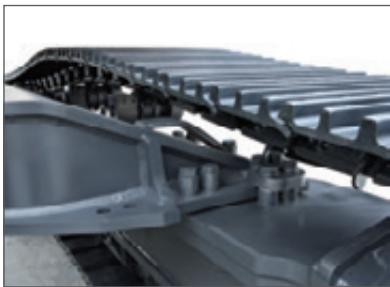

Large Displacement High Efficiency Pump

Large displacement hydraulic implement pumps provide high flow output at lower engine RPM as well as operation at the most efficient engine speed.



Working Mode Selection

The PC490LC-11 excavator is equipped with six working modes (P, E, L, B, ATT/P and ATT/E). Each mode is designed to match engine speed, pump flow, and system pressure to the application. The PC490LC-11 features an attachment mode (ATT/E) that allows operators to run attachments while in Economy mode.

Working Mode	Application	Advantage
P	Power mode	<ul style="list-style-type: none"> •Maximum production/power •Fast cycle times
E	Economy mode	<ul style="list-style-type: none"> •Good cycle times •Better fuel economy
L	Lifting mode	<ul style="list-style-type: none"> •Increases hydraulic pressure
B	Breaker mode	<ul style="list-style-type: none"> •Optimum engine rpm, hydraulic flow
ATT/P	Attachment Power mode	<ul style="list-style-type: none"> •Optimum engine rpm, hydraulic flow, 2-way •Power mode
ATT/E	Attachment Economy mode	<ul style="list-style-type: none"> •Optimum engine rpm, hydraulic flow, 2-way •Economy mode



High Rigidity Work Equipment

Booms and arms are constructed with thick plates of high tensile strength steel. In addition, these structures are designed with large cross sectional areas and large one piece castings in the boom foot, the boom tip, and the arm tip. The result is work equipment that exhibits long term durability and high resistance to bending and torsional stress. A standard HD boom design provides increased strength and reliability.



WORKING ENVIRONMENT

PC490LG-11





Comfortable Working Space

Wide spacious cab

The wide spacious cab includes a heated air suspension seat with reclining backrest. The seat height and position are easily adjusted using a pull-up lever. The armrest position is easily adjusted together with the console. Reclining the seat further enables it to be fully laid back with the headrest attached.

Arm rest with simple height adjustment function

A knob and plunger on the armrests allows easy height adjustment without the use of tools.



Low vibration with cab damper mounting

Automatic climate control

Pressurized cab

Auxiliary input jack

Connecting a regular audio device to the auxiliary jack allows the operator to hear the sound from the stereo speakers installed in the cab.



Standard Equipment

Sliding window glass (left side)



AM/FM stereo radio & ashtray



Remote intermittent wiper with windshield washer

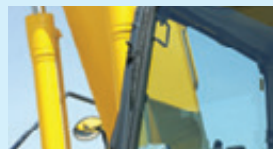

Cigarette lighter



Opening & closing skylight



Magazine box & cup holder



Defroster (conforms to the ISO standard)



One-touch storable front window lower glass



WORKING ENVIRONMENT

PG490LG-11

LARGE HIGH RESOLUTION LCD MONITOR



New Monitor Panel Interface Design

An updated large high resolution LCD color monitor enables accurate and smooth work. The interface has been redesigned to display key machine information in a new user friendly interface. A rear view camera and an DEF level gauge display have been added to the default main screen. The interface has a function that enables the main screen mode to be switched, thus enabling the optimum screen information for the particular work situation to be displayed.

Indicators

- | | |
|------------------------------------|-----------------------------|
| 1 Auto-decelerator | 8 Fuel gauge |
| 2 Working mode | 9 DEF level gauge |
| 3 Travel speed | 10 Service meter, clock |
| 4 Ecology gauge | 11 Fuel consumption gauge |
| 5 Camera display | 12 Guidance icon |
| 6 Engine coolant temperature gauge | 13 Function switches |
| 7 Hydraulic oil temperature gauge | 14 Camera direction display |
| | 15 DEF level caution lamp |

Basic operation switches

- | | |
|-------------------------|-------------------------|
| 1 Auto-decelerator | 4 Buzzer cancel |
| 2 Working mode selector | 5 Wiper |
| 3 Travel speed selector | 6 Window washer |
| | 7 Auto climate controls |

Switchable Display Modes

The main screen display mode can be changed by pressing the pressing the F3 key.

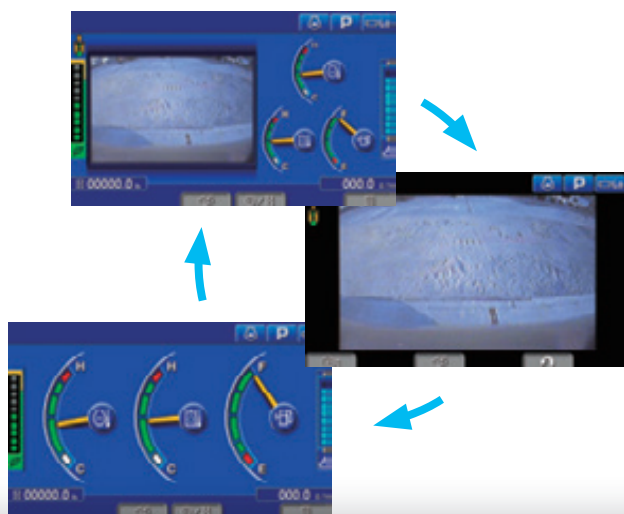

Visual user menu

Pressing the F6 key on the main screen displays the user menu screen. The menus are grouped for each function, and use easy-to-understand icons which enable the machine to be operated easily.



- | | |
|---------------------------------------|--------------------|
| 1 Energy saving guidance | 2 Machine settings |
| 3 Aftertreatment devices regeneration | 4 SCR information |
| 5 Maintenance | 6 Monitor setting |
| | 7 Message check |

Support Efficiency Improvement

Ecology guidance

While the machine is operating, ecology guidance pops up on the monitor screen to notify the operator of the status of the machine in real time.

Ecology gauge & fuel consumption gauge

The monitor screen is provided with an ecology gauge and also a fuel consumption gauge which is displayed continuously. In addition, the operator can set any desired target value of fuel consumption (within the range of the green display), enabling the machine to be operated with better fuel economy.



Ecology gauge Fuel consumption gauge
Ecology guidance

Operator Identification Function

An operator identification ID can be set up for each operator, and used to manage operation information of individual machines using KOMTRAX data. Data sent from KOMTRAX can be used to analyze operation status by operator as well as by machine.



Operation record, fuel consumption history, and ecology guidance record

The ecology guidance menu enables the operator to check the operation record, fuel consumption history and ecology guidance record from the ecology guidance menu, using a single touch, thus enabling the total fuel consumption to be reduced.



Operation record



Fuel consumption history



Ecology guidance record



MAINTENANCE FEATURES

Centralized engine check points

Locations of the engine oil check and filters are integrated into one side to allow easy maintenance and service.



Battery disconnect switch

A standard battery disconnect switch allows a technician to disconnect the power supply and lock out before servicing the machine.

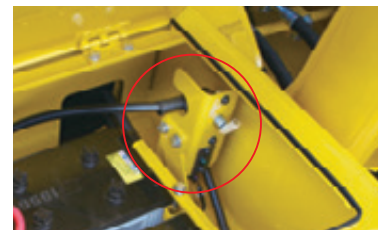

Easy cleaning of cooling unit

Reverse-rotation function of the hydraulic driven fan facilitates cleaning of the cooling unit.

Fuel pre-filter with water separator

Electric fuel priming pump

High efficiency fuel filter with water separator

Easy access to engine oil filter, engine oil, Ecology drain valve, fuel drain valve and water separator drain valve

Cab air filter

Washable cab floor mat

Sloping track frame



Long-life oils, filters

High performance filters are used in the hydraulic circuit and engine. By increasing the oil and filter replacement intervals, maintenance costs can be significantly reduced.

Engine oil & Engine oil filter	every 500 hours
Hydraulic oil	every 5000 hours
Hydraulic oil filter	every 1000 hours



Hydraulic oil filter (Ecology-white element)

Large capacity air cleaner

Large capacity air cleaner is comparable to that of larger machines. The larger air cleaner can extend air cleaner life during long-term operation and helps prevent early clogging, and resulting power loss. A reliable seal design is used for reliability.



Diesel Exhaust Fluid (DEF) tank

A large tank volume extends operating time before refilling and is installed on the right front stairway for ease of access.

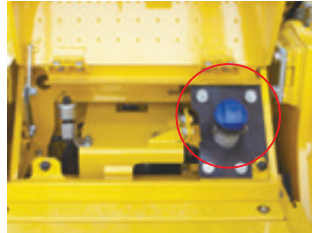

Maintenance Information

“Maintenance time caution lamp” display

When the remaining time to maintenance becomes less than 30 hours*, a maintenance time monitor appears. Pressing the F6 key switches the monitor to the maintenance screen.

* : The setting can be changed within the range between 10 and 200 hours.



Maintenance screen

Manual Stational Regeneration

Under most conditions, active regeneration will occur automatically with no effect on machine operation. In case the operator needs to disable active regeneration or initiate a manual stationary regeneration, this can be easily accomplished through the monitor panel. A soot level indicator is displayed to show how much soot is trapped in the KDPF.



Soot level indicator

Aftertreatment device regeneration screen

Supports the DEF level and refill timing

The DEF level gauge is displayed continuously on the right side of the monitor screen. In addition, when DEF level is low, DEF low level guidance messages appear in pop up displays to inform the operator in real time.



DEF level gauge

DEF low level guidance

DT-type connectors

Sealed DT-type electrical connectors provide high reliability, water and dust resistance.

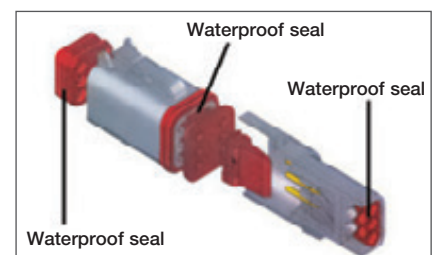

GENERAL FEATURES

ROPS CAB STRUCTURE

ROPS Cab (ISO 12117-2)

The machine is equipped with a ROPS cab that conforms to ISO 12117-2 for excavators as standard equipment. It also satisfies the requirements for Level 1 Operator Protective Guard (OPG) and top guard (ISO 10262).



Rear View Monitoring System

A new rear view monitoring system display has a rear view camera image that is continuously displayed together with the gauges and important vehicle information. This enables the operator to carry out work while easily checking the surrounding area.

Rear view camera



Rear view image on monitor



Low Vibration with Viscous Cab Mounts

The PC490LC-11 uses viscous mounts for the cab that incorporate a longer stroke and the addition of a spring. The cab damper mounting combined with a high rigidity deck reduces vibration at the operator's seat.

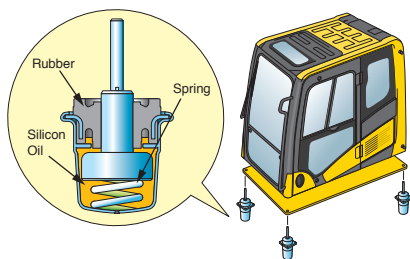

General Features

Secondary engine shut down switch at base of seat to shutdown the engine.



Left and right side hand rails



Seat belt caution indicator



Lock lever

Seat belt retractable

Tempered & tinted glass

Large mirrors

Slip-resistant plates

Thermal and fan guards

Pump/engine room partition

Travel alarm

Large cab entrance step



KOMTRAX EQUIPMENT MONITORING

GET THE WHOLE STORY WITH
KOMTRAX[®]

✓ **WHAT**

- KOMTRAX is Komatsu's remote equipment monitoring and management system
- KOMTRAX **continuously monitors and records** machine health and operational data
- Information such as fuel consumption, utilization, and a detailed history **lowering owning and operating cost**

✓ **WHO**

- KOMTRAX is **standard** equipment on all Komatsu construction products

✓ **WHEN**

- Know when your machines are **running or idling** and make decisions that will improve your fleet utilization
- Detailed movement records ensure you know when and where your equipment is moved
- Up to date records allow you to **know when maintenance is due** and help you plan for future maintenance needs

✓ **WHERE**

- KOMTRAX data **can be accessed virtually anywhere** through your computer, the web or your smart phone
- Automatic alerts keep fleet managers up to date on the latest machine notifications

✓ **WHY**

- Knowledge is power - **make informed decisions** to manage your fleet better
- Knowing your idle time and fuel consumption will help maximize your machine efficiency
- **Take control of your equipment** - any time, anywhere



KOMTRAX[®]

For construction and compact equipment.

KOMTRAX Plus[™]

For production and mining class machines.

KOMATSU PARTS & SERVICE SUPPORT



Every new Komatsu Tier 4 Final construction machine is covered.

The Komatsu CARE program covers all new Komatsu Tier 4 Final construction equipment, whether rented, leased or purchased. For the first 3 years or 2,000 hours, whichever occurs first, you'll receive:

- Regular service at 500, 1,000, 1,500 and 2,000-hr. intervals
- DEF tank breather element replacement at 1,000 hours
- DEF and CCV filters replacement at 2,000 hours
- 50-point inspection by factory-trained technician at each scheduled interval
- Technician labor
- Fluids, oils, coolant, filters, SCR screen, tank breather and parts
- Technician travel to and from your equipment location

Plus Complimentary KDPF replacement and SCR system service for 5 years-no hours limits.

Service will be performed by a Komatsu Distributor and only Komatsu genuine fluids and filters will be used.

Komatsu CARE® services are available from every Komatsu Distributor in the U.S. and Canada.



Komatsu CARE – Extended Coverage

- Extended Coverage can provide peace of mind by protecting customers from unplanned expenses that effect cash flow
- Purchasing extended coverage locks-in the cost of covered parts and labor for the coverage period and helps turn these into fixed costs



Komatsu Parts Support

- 24/7/365 to fulfill your parts needs
- 9 parts Distribution Centers strategically located across the U.S. and Canada
- Distributor network of more than 300 locations across U.S. and Canada to serve you
- Online part ordering through Komatsu eParts
- Remanufactured components with same-as-new warranties at a significant cost reduction



Komatsu Oil and Wear Analysis (KOWA)

- KOWA detects fuel dilution, coolant leaks, and measures wear metals
- Proactively maintain your equipment
- Maximize availability and performance
- Can identify potential problems before they lead to major repairs
- Reduce life cycle cost by extending component life

SPECIFICATIONS



ENGINE

Model.....Komatsu SAA6D125E-7*
 Type.....Water-cooled, 4-cycle, direct injection
 Aspiration.....Komatsu Variable Geometry Turbocharger
 with air-to-air aftercooled EGR
 Number of cylinders..... 6
 Bore..... 125 mm **4.92"**
 Stroke..... 150 mm **5.91"**
 Piston displacement..... 11.04 ltr **674 in³**
 Horsepower:
 SAE J1995.....Gross 270 kW **362 HP**
 ISO 9249 / SAE J1349.....Net 268 kW **359 HP**
 Rated rpm..... 1900
 Governor..... All-speed control, electronic
 Fan drive method for radiator cooling..... Hydraulic

*EPA Tier 4 Final emissions certified



HYDRAULICS

Type ..HydraMind (Hydraulic Mechanical Intelligence) system,
 closed-center system with
 load sensing valve and pressure compensated valves,
 6 selectable working modes

Main pump:
 Pumps for.....Boom, arm, bucket, swing, and travel circuits
 Type.....Variable displacement axial piston type
 Maximum flow..... 780 ltr/min **206 gal/min**

Hydraulic motors:
 Travel..... 2 x axial piston motor with parking brake
 Swing..... 1 x axial piston motor with swing holding brake

Relief valve setting:
 Implement circuits..... 37.3 MPa 380 kgf/cm² **5,400 psi**
 Travel circuit..... 37.3 MPa 380 kgf/cm² **5,400 psi**
 Swing circuit..... 27.9 MPa 285 kgf/cm² **4,050 psi**
 Pilot circuit..... 3.2 MPa 33 kgf/cm² **470 psi**

Hydraulic cylinders:
 (Number of cylinders – bore x stroke x rod diameter)
 Boom..... 2–160 mm x 1570 mm x 110 mm **6.3" x 61.8" x 4.3"**
 Arm..... 1–185 mm x 1820 mm x 120 mm **7.3" x 71.7" x 4.7"**
 Bucket..... 1–160 mm x 1270 mm x 110 mm **6.3" x 50" x 4.3"**



DRIVES AND BRAKES

Steering control.....Two lever with pedals
 Drive method..... Hydrostatic
 Maximum drawbar pull..... 329 kN 33510 kgf **73,880 lbf**
 Gradeability..... 70%, 35°
 Maximum travel speed (auto shift):
 High..... 5.5 km/h **3.4 mph**
 Mid..... 4.2 km/h **2.6 mph**
 Low..... 3.0 km/h **1.9 mph**

Service brake..... Hydraulic lock
 Parking brake..... Mechanical disc



SWING SYSTEM

Driven by..... Hydraulic motor
 Swing reduction..... Planetary gear
 Swing circle lubrication..... Grease-bathed
 Service brake..... Hydraulic lock
 Holding brake/Swing lock..... Mechanical disc brake
 Swing speed..... 9.0 rpm
 Swing torque..... 13414 kg-m **97,024 ft lbs**



UNDERCARRIAGE

Center frame..... X-frame
 Track frame..... Box-section
 Track type..... Sealed
 Track adjuster..... Hydraulic
 Number of shoes (each side)..... 49
 Number of carrier rollers (each side)..... 2
 Number of track rollers (each side)..... 8



COOLANT & LUBRICANT CAPACITY (REFILLING)

Fuel tank..... 650 ltr **172 U.S. gal**
 Radiator..... 47.0 ltr **12.4 U.S. gal**
 Engine..... 38 ltr **10.0 U.S. gal**
 Final drive, each side..... 11.0 ltr **2.9 U.S. gal**
 Swing drive..... 20.0 ltr **5.3 U.S. gal**
 Hydraulic tank..... 248 ltr **65.5 U.S. gal**
 Diesel Exhaust Fluid (DEF) tank..... 39 ltr **10.3 U.S. gal**



OPERATING WEIGHT (APPROXIMATE)

Operating weight includes 7060 mm **23'2"** one-piece HD boom, 3380 mm **11'1"** arm, SAE heaped 2.25 m³ **2.94 yd³** bucket, rated capacity of lubricants, coolant, full fuel tank, operator, and standard equipment.

Triple-Grouser Shoes	Fixed Gauge		Variable Gauge	
	Operating Weight	Ground Pressure	Operating Weight	Ground Pressure
700 mm 28"	47930 kg 105,670 lb	0.73 kg/cm ² 10.38 psi	49005 kg 108,040 lb	0.75 kg/cm ² 10.61 psi
800 mm 31.5"	48430 kg 106,770 lb	0.65 kg/cm ² 9.20 psi	49505 kg 109,140 lb	0.67 kg/cm ² 9.40 psi
900 mm 35.5"	48920 kg 107,850 lb	0.58 kg/cm ² 8.32 psi	49995 kg 110,220 lb	0.60 kg/cm ² 8.50 psi



WORKING FORCES

	Arm Length	3380 mm 11'1"	4000 mm 13'1"
ISO rating	Bucket	275 kN	275 kN
	digging force	28000 kgf / 61,730 lb	28000 kgf / 61,730 lb
	Arm	214 kN	190 kN
SAE rating	crowd force	21800 kgf / 48,060 lb	19400 kgf / 42,770 lb
	Bucket	239 kN	239 kN
	digging force	24400 kgf / 53,790 lb	24400 kgf / 53,790 lb
SAE rating	Arm	205 kN	184 kN
	crowd force	20900 kgf / 46,080 lb	18800 kgf / 41,450 lb

Component Weights

Arm including bucket cylinder and linkage
 3380 mm **11'1"** arm assembly..... 2141 kg **4,720 lb**
 4000 mm **13'1"** arm assembly..... 2408 kg **5,309 lb**
 4800 mm **15'9"** arm assembly..... 2645 kg **5,831 lb**
 One piece HD boom including arm cylinder
 7060 mm **23'2"** boom assembly..... 4017 kg **8,856 lb**
 Boom cylinders x 2..... 366 kg **807 lb**
 Counterweight (standard)..... 9573 kg **21,105 lb**
 Counterweight (for removal system)..... 8700 kg **19,180 lb**
 2.25 m³ **2.94 yd³** bucket - 54" width..... 1867 kg **4,117 lb**

SPECIFICATIONS



DIMENSIONS

Arm Length	2900 mm	9'6"	3380 mm	11'1"	4000 mm	13'1"	4800 mm	15'9"
A Overall length	11995 mm	39'4"	11930 mm	39'2"	11950 mm	39'2"	11795 mm	38'8"
B Length on ground (transport)	7475 mm	24'6"	6705 mm	22'0"	6330 mm	20'9"	6035 mm	19'10"
C Overall height (to top of boom)*	3745 mm	12'3"	3635 mm	11'11"	3885 mm	12'9"	4435 mm	14'7"
D Overall width	3640 mm	11'11"						
E Overall height (to top of cab)*	3360 mm	11'0"						
F Overall height (to top of handrail)*	3450 mm	11'4"						
G Ground clearance, counterweight	1385 mm	4'7"						
H Ground clearance, minimum	550 mm	1'10"						
I Tail swing radius	3645 mm	12'0"						
J Track length on ground	4350 mm	14'3"						
K Track length	5385 mm	17'8"						
L Track gauge	2740 mm	9'0"						
M Width of crawler	3640 mm	11'11"						
N Shoe width	900 mm	35.5"						
O Grouser height	37 mm	1.5"						
P Machine height to top of engine cover	3630 mm	11'11"						
Q Machine upper width **	3145 mm	10'4"						
R Distance, swing center to rear end	3605 mm	11'10"						
Variable Track Gauge Dimensions								
D1 Overall width (crawler extended)	3790 mm	12'5"						
D2 Overall width (crawler retracted)	3290 mm	10'10"						
H Ground clearance, minimum	700 mm	2'3"						
L Track gauge	2890 mm	9'6"						
M1 Width of crawler (crawler extended)	3790 mm	12'5"						
M2 Width of crawler (crawler retracted)	3290 mm	10'10"						
N Shoe width	900 mm	35.5"						

* : Including grouser height

** : Including handrail

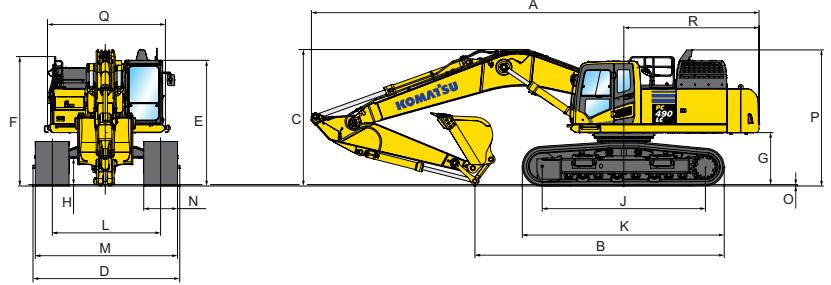
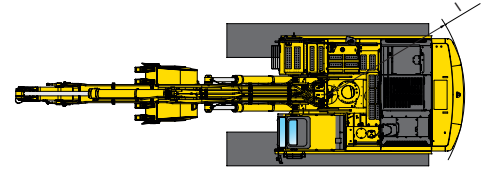

BACKHOE BUCKET, ARM AND BOOM COMBINATION

Bucket Type	Bucket							7.0 m (23'2") HD Boom					
	Capacity	Teeth	Width		Weight		Tip Radius	2.9 m (9'6")	3.4 m (11'1")	4.0 m (13'1")	4.8 m (15'9")		
Komatsu TL	1.12 m ³	1.47 yd³	3	762 mm	30"	1287 kg	2838 lb	1826 mm	72"	●	●	●	●
	1.35 m ³	1.76 yd³	4	914 mm	36"	1441 kg	3176 lb	1826 mm	72"	●	●	●	●
	1.64 m ³	2.15 yd³	4	1067 mm	42"	1561 kg	3442 lb	1826 mm	72"	●	●	●	●
	1.94 m ³	2.54 yd³	5	1219 mm	48"	1714 kg	3779 lb	1826 mm	72"	●	●	○	□
	2.25 m ³	2.94 yd³	6	1372 mm	54"	1867 kg	4117 lb	1826 mm	72"	●	●	○	□
	2.55 m ³	3.34 yd³	6	1524 mm	60"	1988 kg	4382 lb	1826 mm	72"	○	○	□	⊙
	2.87 m ³	3.75 yd³	7	1676 mm	66"	2141 kg	4720 lb	1826 mm	72"	□	□	⊙	X
3.17 m ³	4.15 yd³	7	1829 mm	72"	2261 kg	4985 lb	1826 mm	72"	□	⊙	⊙	X	
Komatsu HP	1.12 m ³	1.47 yd³	3	762 mm	30"	1508 kg	3324 lb	1826 mm	72"	●	●	●	●
	1.35 m ³	1.76 yd³	4	914 mm	36"	1663 kg	3667 lb	1826 mm	72"	●	●	●	●
	1.64 m ³	2.15 yd³	4	1067 mm	42"	1835 kg	4046 lb	1826 mm	72"	●	●	●	●
	1.94 m ³	2.54 yd³	5	1219 mm	48"	1978 kg	4360 lb	1826 mm	72"	●	●	●	□
	2.25 m ³	2.94 yd³	6	1372 mm	54"	2151 kg	4741 lb	1826 mm	72"	●	○	□	⊙
	2.55 m ³	3.34 yd³	6	1524 mm	60"	2293 kg	5056 lb	1826 mm	72"	○	□	□	⊙
	2.87 m ³	3.75 yd³	7	1676 mm	66"	2466 kg	5437 lb	1826 mm	72"	□	⊙	⊙	X
3.17 m ³	4.15 yd³	7	1829 mm	72"	2609 kg	5752 lb	1826 mm	72"	⊙	⊙	X	X	
Komatsu HPS	1.12 m ³	1.47 yd³	3	762 mm	30"	1632 kg	3597 lb	1826 mm	72"	●	●	●	●
	1.35 m ³	1.76 yd³	4	914 mm	36"	1806 kg	3981 lb	1826 mm	72"	●	●	●	●
	1.64 m ³	2.15 yd³	4	1067 mm	42"	2003 kg	4416 lb	1826 mm	72"	●	●	●	●
	1.94 m ³	2.54 yd³	5	1219 mm	48"	2172 kg	4789 lb	1826 mm	72"	●	●	○	□
	2.25 m ³	2.94 yd³	6	1372 mm	54"	2371 kg	5228 lb	1826 mm	72"	●	○	□	⊙
	2.55 m ³	3.34 yd³	6	1524 mm	60"	2540 kg	5600 lb	1826 mm	72"	○	□	⊙	X
	2.87 m ³	3.75 yd³	7	1676 mm	66"	2739 kg	6039 lb	1826 mm	72"	□	⊙	X	X
Komatsu HPX	1.12 m ³	1.47 yd³	3	762 mm	30"	1759 kg	3877 lb	1826 mm	72"	●	●	●	●
	1.35 m ³	1.76 yd³	4	914 mm	36"	1933 kg	4261 lb	1826 mm	72"	●	●	●	●
	1.64 m ³	2.15 yd³	4	1067 mm	42"	2130 kg	4696 lb	1826 mm	72"	●	●	●	○
	1.94 m ³	2.54 yd³	5	1219 mm	48"	2299 kg	5069 lb	1826 mm	72"	●	●	○	□
	2.25 m ³	2.94 yd³	6	1372 mm	54"	2498 kg	5508 lb	1826 mm	72"	□	○	□	⊙
	2.55 m ³	3.34 yd³	6	1524 mm	60"	2667 kg	5880 lb	1826 mm	72"	□	□	⊙	X
	2.87 m ³	3.75 yd³	7	1676 mm	66"	2866 kg	6319 lb	1826 mm	72"	□	⊙	X	X

● - Used with material weights up to 3,500 lb/yd³ - Quarry/rock/high abrasion applications
 ○ - Used with material weights up to 2,500 lb/yd³ - General construction

○ - Used with material weights up to 3,000 lb/yd³ - Tough digging applications
 ⊙ - Used with material weights up to 2,000 lb/yd³ - Light materials applications
 X - Not useable



WORKING RANGE

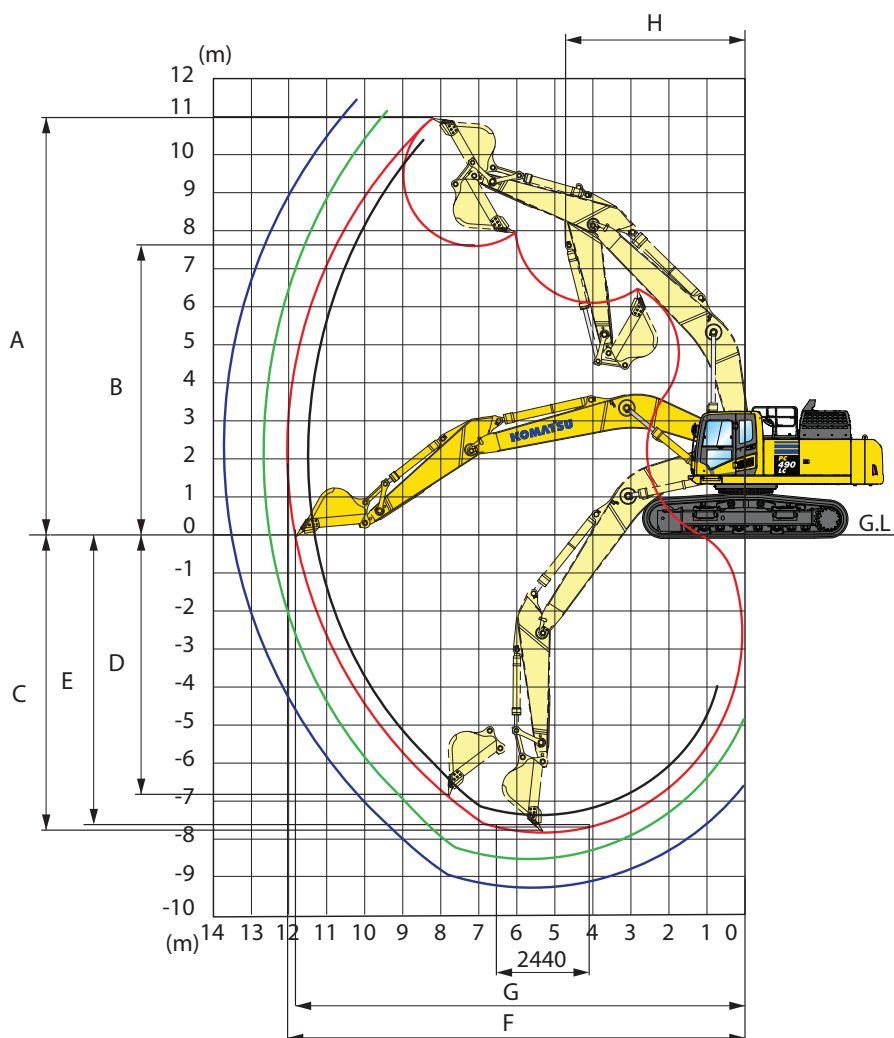

		2900 mm	9'6"	3380 mm	11'1"	4000 mm	13'1"	4800 mm	15'9"
A	Max. digging height	10350 mm	34'0"	10980 mm	36'0"	11090 mm	36'5"	11550 mm	37'11"
B	Max. dumping height	7145 mm	23'5"	7630 mm	25'0"	7780 mm	25'6"	8210 mm	26'11"
C	Max. digging depth	7280 mm	23'11"	7755 mm	25'5"	8380 mm	27'6"	9190 mm	30'2"
D	Max. vertical wall digging depth	5635 mm	18'6"	6805 mm	22'4"	7220 mm	23'8"	8085 mm	26'6"
E	Max. digging depth for 8' level bottom	7090 mm	23'3"	7615 mm	25'0"	8250 mm	27'0"	9080 mm	29'10"
F	Max. digging reach	11445 mm	37'7"	12030 mm	39'6"	12565 mm	41'3"	13365 mm	43'10"
G	Max. digging reach at ground level	11230 mm	36'10"	11810 mm	38'9"	12365 mm	40'7"	13180 mm	43'3"
H	Min. swing radius	4810 mm	15'9"	4735 mm	15'6"	4800 mm	15'9"	4885 mm	16'0"
SAE rating	Bucket digging force at power max.	239 kN 24,400 kg / 53,790 lb		239 kN 24,400 kg / 53,790 lb		239 kN 24,400 kg / 53,790 lb		239 kN 24,400 kg / 53,790 lb	
	Arm crowd force at power max.	245 kN 25000 kg / 55,120 lb		205 kN 20900 kg / 46,080 lb		184 kN 18800 kg / 41,450 lb		162 kN 16500 kg / 36,400 lb	
ISO rating	Bucket digging force at power max.	275 kN 28000 kg / 61,730 lb		275 kN 28000 kg / 61,730 lb		275 kN 28000 kg / 61,730 lb		275 kN 28000 kg / 61,730 lb	
	Arm crowd force at power max.	257 kN 26200 kg / 57,760 lb		214 kN 21800 kg / 48,060 lb		190 kN 19400 kg / 42,770 lb		167 kN 17000 kg / 37,500 lb	

LIFT CAPACITIES



LIFTING CAPACITY WITH LIFTING MODE

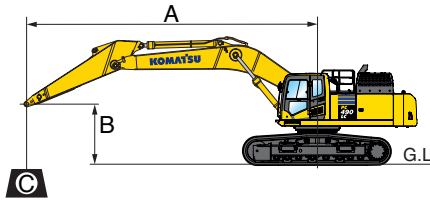

- A: Reach from swing center
- B: Bucket hook height
- C: Lifting capacity
- Cf: Rating over front
- Cs: Rating over side
- ⊗: Rating at maximum reach

- Conditions:
- Boom length: 7060 mm 23' 2"
 - Bucket: None
 - Undercarriage: Fixed Gauge
 - Lifting mode: On

Arm: 2900 mm 9'6"		Bucket: None				Shoes: 900 mm 35.5" triple grouser						Unit: kg lb	
B	A MAX	3.0 m 10'		4.6 m 15'		6.1 m 20'		7.6 m 25'		9.1 m 30'		⊗ MAX	
		Cf	Cs	Cf	Cs	Cf	Cs	Cf	Cs	Cf	Cs	Cf	Cs
7.6 m 25'	7.9 m 26'							* 12340	11260			* 12260	10550
								* 27200	24800			* 27000	23200
6.1 m 20'	8.8 m 29'					* 14370	* 14370	* 12730	11100			* 12030	8960
						* 31600	* 31600	* 28000	24400			* 26500	19700
4.6 m 15'	9.3 m 31'			* 21420	* 21420	* 16160	14750	* 13570	10800	* 12090	8330	* 11980	8110
				* 47200	* 47200	* 35600	32500	* 29900	23800	* 26600	18300	* 26400	17800
3.0 m 10'	9.6 m 31'					* 17970	14070	* 14490	10450	* 12460	8170	* 11760	7680
						* 39600	31000	* 31900	23000	* 27400	18000	* 25900	16900
1.5 m 5'	9.6 m 31'					* 19120	13570	* 15170	10160	12380	8020	11630	7560
						* 42100	29900	* 33400	22400	27300	17600	25600	16600
0 m 0'	9.3 m 31'			* 21910	19890	* 19290	13300	* 15340	9970	12280	7920	11970	7740
				* 48300	43800	* 42500	29300	* 33800	21900	27000	17400	26300	17000
-1.5 m -5'	8.8 m 29'			* 23330	19970	* 18470	13240	* 14770	9910			* 12350	8300
				* 51400	44000	* 40700	29200	* 32500	21800			* 27200	18300
-3.0 m -10'	8.0 m 26'	* 24120	* 24120	* 20520	20200	* 16560	13350	* 13040	10000			* 12210	9500
		* 53100	* 53100	* 45200	44500	* 36500	29400	* 28700	22000			* 26900	20900
-4.6 m -15'	6.7 m 22'			* 16030	* 16030	* 12840	* 12840					* 11420	* 11420
				* 35300	* 35300	* 28300	* 28300					* 25100	* 25100

*Load is limited by hydraulic capacity rather than tipping. Ratings are based on ISO standard No. 10567. Rated loads do not exceed 87% of hydraulic lift capacity or 75% of tipping load.

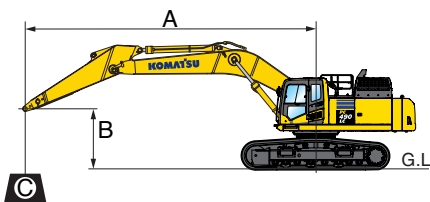

- A: Reach from swing center
- B: Bucket hook height
- C: Lifting capacity
- Cf: Rating over front
- Cs: Rating over side
- ⊗: Rating at maximum reach

- Conditions:
- Boom length: 7060 mm 23' 2"
 - Bucket: None
 - Undercarriage: Fixed Gauge
 - Lifting mode: On

Arm: 3380 mm 11'1"		Bucket: None				Shoes: 900 mm 35.5" triple grouser						Unit: kg lb	
B	A MAX	3.0 m 10'		4.6 m 15'		6.1 m 20'		7.6 m 25'		9.1 m 30'		⊗ MAX	
		Cf	Cs	Cf	Cs	Cf	Cs	Cf	Cs	Cf	Cs	Cf	Cs
9.1 m 30'	7.5 m 24'											* 9700	* 9700
												* 21300	* 21300
7.6 m 25'	8.6 m 28'							* 11720	11460			* 9200	9200
								* 25800	25200			* 20200	20200
6.1 m 20'	9.4 m 31'					* 12230	11270	* 11430	8590	* 11770	8460	* 9070	8190
						* 26900	24800	* 25200	18900	* 20000	18000	* 20000	18000
4.6 m 15'	9.9 m 33'			* 20080	* 20080	* 15510	15000	* 13160	10950	* 11770	8460	* 9210	7500
				* 44200	* 44200	* 34200	33000	* 29000	24100	* 25900	18600	* 20300	16500
3.0 m 10'	10.1 m 33'			* 24120	21240	* 17470	14300	* 14190	10590	* 12260	8270	* 9580	7150
				* 53100	46800	* 38500	31500	* 31200	23300	* 27000	18200	* 21100	15700
1.5 m 5'	10.1 m 33'			* 19210	* 19210	* 18890	13740	* 15020	10270	12460	8090	* 10240	7050
				* 42300	* 42300	* 41600	30300	* 33100	22600	27400	17800	* 22500	15500
0 m 0'	9.9 m 33'			* 21790	20000	* 19390	13410	* 15390	10040	12320	7970	11050	7190
				* 48000	44100	* 42700	29500	* 33900	22100	27100	17500	24300	15800
-1.5 m -5'	9.4 m 31'	* 15850	* 15850	* 24430	19990	* 18910	13290	* 15080	9940	* 12170	7930	* 11600	7640
		* 34900	* 34900	* 53800	44000	* 41600	29300	* 33200	21900	* 26800	17400	* 25500	16800
-3.0 m -10'	8.7 m 28'	* 24660	* 24660	* 21940	20160	* 17370	13340	* 13810	9980			* 11490	8560
		* 54300	* 54300	* 48300	44400	* 38300	29400	* 30400	22000			* 25300	18800
-4.6 m -15'	7.5 m 25'	* 21900	* 21900	* 17970	* 17970	* 14350	13570					* 10930	10450
		* 48200	* 48200	* 39600	* 39600	* 31600	29900					* 24100	23000

*Load is limited by hydraulic capacity rather than tipping. Ratings are based on ISO standard No. 10567. Rated loads do not exceed 87% of hydraulic lift capacity or 75% of tipping load.



LIFTING CAPACITY WITH LIFTING MODE

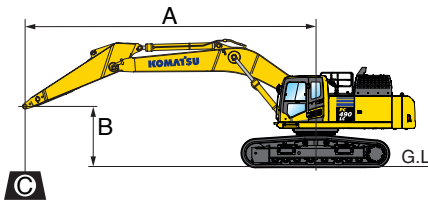

- A: Reach from swing center
- B: Bucket hook height
- C: Lifting capacity
- Cf: Rating over front
- Cs: Rating over side
- ☉: Rating at maximum reach

- Conditions:
- Boom length: 7060 mm 23' 2"
 - Bucket: None
 - Undercarriage: Fixed Gauge
 - Lifting mode: On

Arm: 4000 mm 13'1"		Bucket: None				Shoes: 900 mm 35.5" triple grouser				Unit: kg lb				
B	A	MAX	3.0 m 10'		4.6 m 15'		6.1 m 20'		7.6 m 25'		9.1 m 30'		☉ MAX	
			Cf	Cs	Cf	Cs	Cf	Cs	Cf	Cs	Cf	Cs	Cf	Cs
9.1 m 30'	8.2 m 27'											* 8240	* 8240	
7.6 m 25'	9.3 m 30'										* 8750	8670	* 7890	* 7890
6.1 m 20'	10.0 m 33'							* 11350	11330	* 10650	8610	* 7810	7470	
4.6 m 15'	10.5 m 34'							* 25000	24900	* 23400	18900	* 17200	16400	
3.0 m 10'	10.7 m 35'			* 22270	21570	* 16440	14370	* 13480	10570	* 11710	8210	* 8230	6570	
1.5 m 5'	10.7 m 35'			* 25080	20330	* 18130	13700	* 14470	10190	* 12240	7990	* 8760	6470	
0 m 0'	10.5 m 34'			* 55300	44800	* 39900	30200	* 31900	22400	* 26900	17600	* 19300	14200	
-1.5 m -5'	10.0 m 33'	* 15460	* 15460	* 23770	19770	* 19010	13260	* 15050	9900	12190	7820	* 9590	6570	
-3.0 m -10'	9.3 m 30'	* 52400	* 43500	* 41900	29200	* 33100	21800	* 21800	21800	* 26800	17200	* 21100	14400	
-4.6 m -15'	8.2 m 27'	* 15460	* 15460	* 25010	19610	* 18940	13050	* 15040	9740	12090	7730	10720	6920	
-6.1 m -20'	6.6 m 22'	* 34100	* 34100	* 55100	43200	* 41700	28700	* 33100	21400	* 26600	17000	* 23600	15200	
		* 22240	* 22240	* 23040	19700	* 17870	13040	* 14220	9720	* 11220	7760	* 10930	7640	
		* 49000	* 49000	* 50800	43400	* 39400	28700	* 31300	21400	* 24700	17100	* 24100	16800	
		* 25460	* 25460	* 19730	* 19730	* 15550	13200	* 12100	9870			* 10700	9040	
		* 56100	* 56100	* 43500	* 43500	* 34200	29100	* 26600	21700			* 23600	19900	
		* 14280	* 14280	* 10970	* 10970							* 9670	* 9670	
		* 31400	* 31400	* 24100	* 24100							* 21300	* 21300	

*Load is limited by hydraulic capacity rather than tipping. Ratings are based on ISO standard No. 10567. Rated loads do not exceed 87% of hydraulic lift capacity or 75% of tipping load.

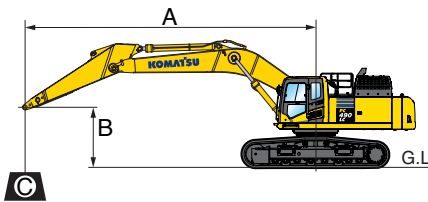

- A: Reach from swing center
- B: Bucket hook height
- C: Lifting capacity
- Cf: Rating over front
- Cs: Rating over side
- ☉: Rating at maximum reach

- Conditions:
- Boom length: 7060 mm 23' 2"
 - Bucket: None
 - Undercarriage: Fixed Gauge
 - Lifting mode: On

Arm: 4800 mm 15'9"		Bucket: None				Shoes: 900 mm 35.5" triple grouser				Unit: kg lb				
B	A	MAX	3.0 m 10'		4.6 m 15'		6.1 m 20'		7.6 m 25'		9.1 m 30'		☉ MAX	
			Cf	Cs	Cf	Cs	Cf	Cs	Cf	Cs	Cf	Cs	Cf	Cs
9.1 m 30'	9.2 m 30'										* 6970	* 6620	* 6620	
7.6 m 25'	10.2 m 33'										* 15300	* 15300	* 14600	* 14600
6.1 m 20'	10.9 m 36'										* 9450	8830	* 6360	* 6360
4.6 m 15'	11.3 m 37'										* 20800	19400	* 14000	* 14000
3.0 m 10'	11.5 m 38'							* 11310	11130	* 10320	8500	* 6350	6140	
1.5 m 5'	11.5 m 38'							* 24900	24500	* 22700	18700	* 14000	13500	
0 m 0'	11.3 m 37'	* 19860	* 19860	* 15080	14630	* 12560	10670	* 12560	10670	* 11030	8240	* 6550	5880	
-1.5 m -5'	10.9 m 36'	* 43700	* 43700	* 33200	32200	* 27700	23500	* 24300	18100	* 14400	12900			
-3.0 m -10'	10.2 m 33'	* 23500	20710	* 17100	13840	* 13740	10230	* 11710	7980	* 6890	5790			
-4.6 m -15'	9.2 m 30'	* 51800	45600	* 37700	30500	* 30300	22500	* 25800	17500	* 15200	12700			
-6.1 m -20'	7.8 m 26'	* 10360	* 10360	* 25290	19800	* 18430	13270	* 14590	9860	12130	7750	* 7430	5860	
		* 14230	* 14230	* 25390	19410	* 18860	12930	* 14920	9630	11970	7610	* 8260	6110	
		* 31300	* 31300	* 55900	42800	* 41500	28500	* 32900	21200	* 26300	16700	* 18200	13400	
		* 19240	* 19240	* 24180	19360	* 18350	12820	* 14570	9530	* 11820	7560	* 9580	6630	
		* 42400	* 42400	* 53300	42600	* 40400	28200	* 32100	21000	* 26000	16600	* 21100	14600	
		* 25760	* 25760	* 21670	19540	* 16760	12890	* 13260	9590	* 10180	7660	* 9990	7580	
		* 56700	* 56700	* 47700	43000	* 36900	28400	* 29200	21100	* 22400	16900	* 22000	16700	
		* 22870	* 22870	* 17460	* 17460	* 13600	13160	* 10130	9850			* 9540	9510	
		* 50400	* 50400	* 38400	* 38400	* 29900	29000	* 22300	21700			* 21000	20900	

*Load is limited by hydraulic capacity rather than tipping. Ratings are based on ISO standard No. 10567. Rated loads do not exceed 87% of hydraulic lift capacity or 75% of tipping load.

LIFT CAPACITIES



LIFTING CAPACITY WITH LIFTING MODE

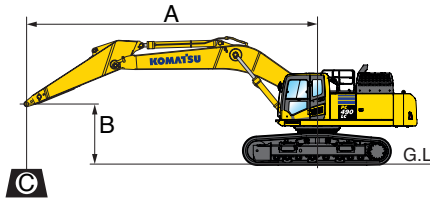

- A: Reach from swing center
- B: Bucket hook height
- C: Lifting capacity
- Cf: Rating over front
- Cs: Rating over side
- ⊗: Rating at maximum reach

- Conditions:
- Boom length: 7060 mm 23' 2"
 - Bucket: None
 - Undercarriage: Variable Gauge
 - Lifting mode: On

Arm: 2900 mm 9'6"		Bucket: None				Shoes: 900 mm 35.5" triple grouser				Unit: kg lb			
B	A MAX	3.0 m 10'		4.6 m 15'		6.1 m 20'		7.6 m 25'		9.1 m 30'		⊗ MAX	
		Cf	Cs	Cf	Cs	Cf	Cs	Cf	Cs	Cf	Cs	Cf	Cs
7.6 m 25'	7.9 m 26'							* 12340	12030			* 12260	11270
6.1 m 20'	8.8 m 29'					* 14370	* 14370	* 12730	11880			* 12030	9590
4.6 m 15'	9.3 m 31'			* 21420	* 21420	* 16160	15840	* 13570	11570	* 12090	8920	* 11980	8680
3.0 m 10'	9.6 m 31'			* 47200	* 47200	* 35600	34900	* 29900	25500	* 26600	19600	* 26400	19100
1.5 m 5'	9.6 m 31'					* 17970	15150	* 14490	11220	* 12460	8760	* 12030	8230
0 m 0'	9.3 m 31'			* 19120	14640	* 15170	10920	12670	8610	11900	8110		
-1.5 m -5'	8.8 m 29'			* 42100	32200	* 33400	24000	27900	18900	26200	17800		
-3.0 m -10'	8.0 m 26'	* 21910	21660	* 19290	14370	* 15340	10730	12560	8510	12250	8310		
-4.6 m -15'	6.7 m 22'	* 48300	47700	* 42500	31600	* 33800	23600	27700	18700	27000	18300		
		* 23330	21750	* 18470	14310	* 14770	10670			* 12350	8920		
		* 51400	47900	* 40700	31500	* 32500	23500			* 27200	19600		
		* 20520	20520	* 16560	14420	* 13040	10760			* 12210	10210		
		* 16030	16030	* 12840	12840					* 11420	11420		
		* 35300	35300	* 28300	28300					* 25100	25100		

*Load is limited by hydraulic capacity rather than tipping. Ratings are based on ISO standard No. 10567. Rated loads do not exceed 87% of hydraulic lift capacity or 75% of tipping load.

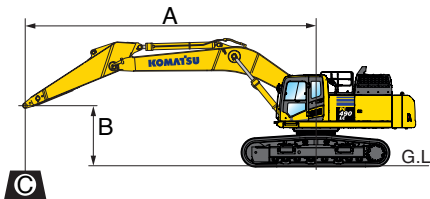

- A: Reach from swing center
- B: Bucket hook height
- C: Lifting capacity
- Cf: Rating over front
- Cs: Rating over side
- ⊗: Rating at maximum reach

- Conditions:
- Boom length: 7060 mm 23' 2"
 - Bucket: None
 - Undercarriage: Variable Gauge
 - Lifting mode: On

Arm: 3380 mm 11'1"		Bucket: None				Shoes: 900 mm 35.5" triple grouser				Unit: kg lb			
B	A MAX	3.0 m 10'		4.6 m 15'		6.1 m 20'		7.6 m 25'		9.1 m 30'		⊗ MAX	
		Cf	Cs	Cf	Cs	Cf	Cs	Cf	Cs	Cf	Cs	Cf	Cs
9.1 m 30'	7.5 m 24'											* 9700	* 9700
7.6 m 25'	8.6 m 28'							* 11720	* 11720			* 21300	* 21300
6.1 m 20'	9.4 m 31'					* 12230	12050	* 11430	9180	* 9070	8760	* 20900	19300
4.6 m 15'	9.9 m 33'			* 20080	* 20080	* 15510	* 15510	* 13160	11730	* 11770	9050	* 9210	8030
3.0 m 10'	10.1 m 33'			* 44200	* 44200	* 34200	* 34200	* 29000	25800	* 25900	19900	* 20300	17700
1.5 m 5'	10.1 m 33'			* 24120	23050	* 17470	15390	* 14190	11360	* 12260	8860	* 9580	7660
0 m 0'	9.9 m 33'			* 53100	50800	* 38500	33900	* 31200	25000	* 27000	19500	* 21100	16800
-1.5 m -5'	9.4 m 31'	* 19210	* 19210	* 18890	14820	* 15020	11030	* 12650	8680	* 10240	7560		
-3.0 m -10'	8.7 m 28'	* 42300	* 42300	* 41600	32600	* 33100	24300	* 27900	19100	* 22500	16600		
-4.6 m -15'	7.5 m 25'	* 21790	21770	* 19390	14490	* 15390	10800	12610	8550	* 11290	7720		
		* 15850	* 15850	* 24430	21760	* 18910	14360	* 15080	10700	* 12170	8510	* 11600	8200
		* 34900	* 34900	* 53800	47900	* 41600	31600	* 33200	23600	* 26800	18700	* 25500	18000
		* 24660	* 24660	* 21950	21940	* 17370	14410	* 13810	10740			* 11490	9190
		* 54300	* 54300	* 48300	48300	* 38300	31700	* 30400	23600			* 25300	20200
		* 21900	* 21900	* 17970	* 17970	* 14350	* 14350					* 10930	* 10930
		* 48200	* 48200	* 39600	* 39600	* 31600	* 31600					* 24100	* 24100

*Load is limited by hydraulic capacity rather than tipping. Ratings are based on ISO standard No. 10567. Rated loads do not exceed 87% of hydraulic lift capacity or 75% of tipping load.



LIFTING CAPACITY WITH LIFTING MODE

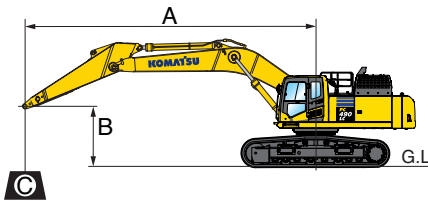

- A: Reach from swing center
- B: Bucket hook height
- C: Lifting capacity
- Cf: Rating over front
- Cs: Rating over side
- ☉: Rating at maximum reach

- Conditions:
- Boom length: 7060 mm 23' 2"
 - Bucket: None
 - Undercarriage: Variable Gauge
 - Lifting mode: On

Arm: 4000 mm 13'1"		Bucket: None				Shoes: 900 mm 35.5" triple grouser				Unit: kg lb				
B	A	MAX	3.0 m 10'		4.6 m 15'		6.1 m 20'		7.6 m 25'		9.1 m 30'		☉ MAX	
			Cf	Cs	Cf	Cs	Cf	Cs	Cf	Cs	Cf	Cs	Cf	Cs
9.1 m 30'	8.2 m 27'											* 8240	* 8240	
7.6 m 25'	9.3 m 30'										* 8750	* 8750	* 7890	* 7890
6.1 m 20'	10.0 m 33'							* 11350	* 11350	* 10650	9210	* 7810	* 7810	* 17400
4.6 m 15'	10.5 m 34'							* 25000	* 25000	* 23400	20300	* 17200	* 17200	* 17200
3.0 m 10'	10.7 m 35'							* 14350	* 14350	* 12350	11750	* 11120	9030	* 7930
1.5 m 5'	10.7 m 35'							* 31600	* 31600	* 27200	25900	* 24500	19900	* 17400
0 m 0'	10.5 m 34'							* 16440	15460	* 13480	11340	* 11710	8800	* 8230
-1.5 m -5'	10.0 m 33'	* 15460	* 15460	* 22270	* 22270	* 25080	22120	* 18130	14780	* 14470	10950	* 12240	8580	* 8760
-3.0 m -10'	9.3 m 30'	* 34100	* 34100	* 49100	* 49100	* 50800	* 50800	* 39400	31100	* 31000	23100	* 24700	18400	* 21000
-4.6 m -15'	8.2 m 27'	* 56100	* 56100	* 52400	* 47400	* 41900	* 31600	* 31600	* 33100	23500	27500	18500	* 21100	15500
-6.1 m -20'														

*Load is limited by hydraulic capacity rather than tipping. Ratings are based on ISO standard No. 10567. Rated loads do not exceed 87% of hydraulic lift capacity or 75% of tipping load.

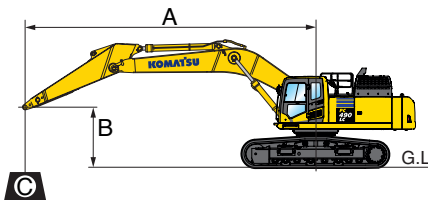

- A: Reach from swing center
- B: Bucket hook height
- C: Lifting capacity
- Cf: Rating over front
- Cs: Rating over side
- ☉: Rating at maximum reach

- Conditions:
- Boom length: 7060 mm 23' 2"
 - Bucket: None
 - Undercarriage: Variable Gauge
 - Lifting mode: On

Arm: 4800 mm 15'9"		Bucket: None				Shoes: 900 mm 35.5" triple grouser				Unit: kg lb				
B	A	MAX	3.0 m 10'		4.6 m 15'		6.1 m 20'		7.6 m 25'		9.1 m 30'		☉ MAX	
			Cf	Cs	Cf	Cs	Cf	Cs	Cf	Cs	Cf	Cs	Cf	Cs
9.1 m 30'	9.2 m 30'											* 6970	* 6620	* 6620
7.6 m 25'	10.2 m 33'											* 15300	* 15300	* 14600
6.1 m 20'	10.9 m 36'											* 9450	9430	* 6360
4.6 m 15'	11.3 m 37'											* 20800	20800	* 14000
3.0 m 10'	11.5 m 38'											* 9740	9310	* 6290
1.5 m 5'	11.5 m 38'											* 21400	20500	* 13800
0 m 0'	11.3 m 37'											* 11310	* 11310	* 13800
-1.5 m -5'	10.9 m 36'	* 19860	* 19860	* 19860	* 19860	* 19860	* 19860	* 15080	* 15080	* 12560	11440	* 11030	8830	* 6550
-3.0 m -10'	10.2 m 33'	* 43700	* 43700	* 43700	* 43700	* 43700	* 43700	* 33200	* 33200	* 27700	25200	* 24300	19400	* 14400
-4.6 m -15'	9.2 m 30'	* 51800	* 49600	* 49600	* 49600	* 49600	* 49600	* 37700	32900	* 30300	24200	* 25800	18800	* 15200
-6.1 m -20'	7.8 m 26'	* 23500	22510	* 21580	21580	* 18430	14340	* 17100	14930	* 13740	10990	* 11710	8570	* 6890
		* 10360	* 10360	* 25290	* 25290	* 21580	* 18430	* 40600	31600	* 32100	23400	* 26800	18400	* 16300
		* 14230	* 14230	* 25390	21180	* 18860	14000	* 14920	10390	12250	8190	* 8260	6580	
		* 31300	* 31300	* 55900	46700	* 41500	30800	* 32900	22900	27000	18000	* 18200	14500	
		* 19240	* 19240	* 24180	21130	* 18350	13880	* 14570	10290	* 11820	8150	* 9580	7130	
		* 42400	* 42400	* 53300	46500	* 40400	30600	* 32100	22700	* 26000	17900	* 21100	15700	
		* 25760	* 25760	* 21670	21310	* 16760	13960	* 13260	10350	* 10180	8250	* 9990	8160	
		* 56700	* 56700	* 47700	46900	* 36900	30700	* 29200	22800	* 22400	18100	* 22000	18000	
		* 22870	* 22870	* 17460	* 17460	* 13600	* 13600	* 10130	* 10130			* 9540	* 9540	
		* 50400	* 50400	* 38400	* 38400	* 29900	* 29900	* 22300	* 22300			* 21000	* 21000	

*Load is limited by hydraulic capacity rather than tipping. Ratings are based on ISO standard No. 10567. Rated loads do not exceed 87% of hydraulic lift capacity or 75% of tipping load.



STANDARD EQUIPMENT

- 3 speed travel with auto shift
- Alternator, 90 Ampere, 24V
- AM/FM radio
- Arm holding valve
- Automatic engine warm-up system
- Automatic climate control/air conditioner/heater/defroster
- Auto idle
- Auto idle shut down, programmable
- Auxiliary input (3.5mm jack)
- Batteries, large capacity (2 x 12V)
- Battery master disconnect switch
- Boom holding valves
- Carrier rollers, (2 each side)
- Converter, (2) x 12V
- Counterweight, 9573 kg **21,105 lb**
- Dry type air cleaner, double element
- Electric horn
- Engine, Komatsu SAA6D125E-7
- Engine coolant to -25°C **-13°F**
- EMMS monitoring system
- Engine overheat prevention system
- Extended work equipment grease interval
- Fan guard structure
- Fuel priming pump, 24V
- Fuel system pre-filter 10 micron
- Grease sealed track chain
- High back air suspension seat, with heat
- Hydraulic cooling fan (reversible)
- Hydraulic track adjusters
- KOMTRAX® Level 5.0
- Large LCD color monitor, high resolution
- Lock lever
- Mirrors, (LH and RH)
- Operator Protective Top Guard (OPG), Level 1
- Operator identification system
- Pattern change valve (ISO to BH control)
- Power maximizing system
- PPC hydraulic control system
- Pump/engine room partition cover
- Radiator and oil cooler dustproof net
- Rear reflectors
- Rearview monitoring system (1 camera)
- Revolving frame deck guard
- Revolving frame undercovers
- ROPS cab (ISO12117-2)
- Seat belt indicator
- Seat belt, retractable, 76mm **3"**
- Secondary engine shutoff switch
- Service valve
- Skylight
- Slip resistant foot plates
- Starter motor, 11.0kW/24V x 1
- Suction fan
- Thermal and fan guards
- Track frame swivel guard
- Track roller guards, center section
- Track rollers, 8 (each side)
- Track shoes, triple grouser, 700mm **28"**
- Travel alarm
- Two boom mode settings
- Working lights, 2 (boom and RH front)
- Working mode selection system



OPTIONAL EQUIPMENT

- Arms
 - 2900 mm **9'6"** arm assembly
 - 3380 mm **11'1"** arm assembly
 - 3380 mm **11'1"** arm assembly with piping
 - 4000 mm **13'1"** arm assembly
 - 4800 mm **15'9"** arm assembly
- Booms
 - 7000 mm **23'2"** HD boom assembly
 - 7000 mm **23'2"** HD boom assembly with piping
- Cab guards
 - Lower front window guard
 - Full front guard, OPG Level 1
 - Full front guard, OPG Level 2
 - Bolt-on top guard, OPG Level 2
- Counterweight removal system
- Counterweight, 12316 kg **27,153 lb** with revolving frame reinforcement
- High altitude arrangement
- High pressure in-line hydraulic filters
- Hydraulic control unit, 1 actuator
- Proportional control handles
- Rain visor
- Revolving frame undercovers, heavy duty
- Revolving frame undercovers, severe duty
- Sun visor
- Straight travel pedal
- Track roller guards, full length
- Track shoes, triple grouser, 800 mm **31.5"**
- Track shoes, triple grouser, 900 mm **35.5"**
- Working lights, front, two additional cab mounted
- Variable track gauge



ATTACHMENT OPTIONS

- Grade control systems
- Hydraulic couplers
- Hydraulic kits, field installed
- Load hold, anti-burst valves
- Material handler front
- Super long fronts
- PSM thumbs
- Rockland thumbs
- Vandalism protection guards with storage box

For a complete list of available attachments, please contact your local Komatsu distributor.



Note: All comparisons and claims of improved performance made herein are made with respect to the prior Komatsu model unless otherwise specifically stated.