

ALL SEASON • ALL TERRAIN • SIX PASSENGERS

SINCE 1967



Amphibious UTV

TRACKED VEHICLE SOLUTIONS



Extreme Off-Road Performance

2013
Commercial Vehicles

ARGO: TRACKED EXTREME TERRAIN VEHICLES, VERSATILITY AT WORK

Your work demands that you get to remote sites through challenging terrain with your equipment and crew. Performance and time are crucial factors in the success of your operation. **Designed for reliability** in the toughest conditions, the amphibious ARGO crosses ponds and streams, travels through deep mud and over rocks, deep snow and ice. The all season ARGO transports up to six passengers and has a **load capacity of up to 1500 lbs.** An optional amphibious trailer carries an additional 600 lbs.

EASY STEERING

Traditional skid steering

ARGO with ADMIRAL Transmission

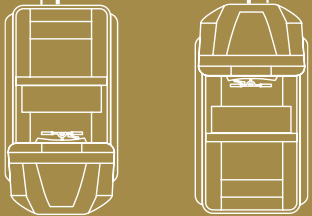

- Less engine power required to steer in high gear.
- Reduces the need to operate in low gear.



The ARGO is the preferred choice when extreme off-road mobility is required. Applications include utilities, natural resource exploration, mining, fire & rescue, forestry, construction and the defense sector.

Available in tracked and non-tracked configurations



THE BEST AND TOUGHEST ARGO EVER BUILT!

Argo 8x8 XTI

ADMIRAL steering transmission for all season, extreme terrain performance

Optional automated chain lubrication system

Heavy duty track option

Adaptable rear cargo area option

Optional suspension seats

High Operator Safety

Minimal environmental impact due to low ground pressure

The ARGO 8x8 XTI is an amphibious all terrain utility vehicle designed to meet the needs of commercial users world-wide. It features a Kohler EFI engine and ODG patent-pending, triple differential, ADMIRAL transmission. The main chassis has been engineered using field-proven technology, allowing for increased payloads and greater durability. The vehicle has been designed to quickly and easily interchange from one application to another with common frame mounting locations. Greater serviceability is achieved by easily removing body panels and screens.



Safety

...always in Season

For safety, we recommend wearing approved helmets and eye protection. When operating in water, always wear approved Personal Floatation Devices. Always remain seated while in the ARGO.

NATURAL RESOURCES AND UTILITIES



The versatility of ARGO vehicles makes them well suited for utility line service!

Crews and equipment have to travel miles through challenging terrain to inspect power lines or prospect new drilling sites. Helicopters or expensive tracked vehicles may be able to get the job done, but at what cost? Today's cost conscious industry leaders rely on ARGO vehicles to get the job done in extreme terrain conditions.



Use ARGO vehicles to transport people, equipment and supplies or pull cables and utility poles to remote work sites.

- Line Construction and Maintenance
- Geological Surveys
- Communications Equipment Management
- Resource Exploration

WHEN EVERY SECOND COUNTS, COUNT ON ARGO VEHICLES



Many emergency tasks require the extra advantage that only the ARGO can provide. The all terrain ARGO 8x8 transports personnel and equipment to the accident site and evacuates the injured. Add the ARGO to your rescue fleet for the added assurance you need when the odds are stacked against you.

Don't wait until your next emergency.

ARGO vehicles can be installed with spraying equipment and traverse the roughest terrain to extinguish isolated brush fires. Equip the ARGO with insect control devices and you now have a vehicle with unlimited potential that will access remote regions and target specific problem areas. These reliable, extreme terrain vehicles are unmatched by any in the industry.



ARGO 8x8 750 HDi with spraying equipment for insect abatement



8x8 Centaur with customized equipment for emergency response



DEFENSE: MILITARY AND HUMANITARIAN APPLICATIONS

ARGO vehicles are air deliverable, can be used in all seasons and are developed to accommodate all terrain conditions. Their rapid deployment capability, together with the modular flexibility of the system facilitates many tasks and applications.

- Rapid manpower mobility
- Supply and re-supply of equipment and operational consumables
- Communications command modules
- Reconnaissance and surveillance modules
- Peacekeeping force mobility
- Agility in accessing dense urban areas

ARGO vehicles can be converted for specialized unmanned surveillance or scout operation.



Scandinavia



Germany



U.S.A.



Middle East



South Africa



Canada



Environmental Impact:

From the unique tread pattern of the tires to the low ground pressure, every ARGO model is designed to minimize its environmental footprint.



Resort Lodges, Outfitters and Ecotourism

The multi-passenger ARGO is the perfect vehicle for wilderness exploration, scenic tours, photo safaris and everything in-between. Outfitters, lodges and eco-tour operators can now offer their customers a unique and reliable outdoor experience. Take advantage of your ARGO to get the work done around your property as well. The rugged ARGO tows and carries loads, and allows you to work in areas that are normally inaccessible at certain times of the year.

- Fishing, Ice Fishing and Hunting Lodges
- Ecotour Operators
- Fun Rides and Support Vehicle
- Trail Grooming and Maintenance



Agriculture and Woodlot Management

Spring thaws and heavy rains can create difficult situations for working in dense bush and rugged terrain. With the ARGO you can operate in any season, tapping maple trees, harvesting logs, creating hiking and cross-country ski trails, and transporting equipment and crew. ARGO vehicles offer tremendous maneuverability through dense bush and their light footprint and powerful traction make even challenging terrain a breeze.

- Spraying, Seeding and Feeding
- Pulling Logs and Hauling Trailers
- Harvesting Palm Oil Fruit
- Plowing Snow
- Transporting People and Supplies



Safety
...always in Season

For safety, we recommend wearing helmets and eye protection.

ARGO 8X8 CENTAUR AND ARGO 8X8 XTI

ARGO 8X8 CENTAUR

An all terrain utility vehicle featuring a 34 hp (25.3 kW) Briggs & Stratton Daihatsu, turbo diesel, in-line 3 cylinder, 4 cycle, liquid cooled engine and patented CENTAURMATIC transmission. The ARGO CENTAUR is designed to go through flooded areas or across shallow rivers and streams with a fording depth of 26" (660 mm).

SAFETY AND STABILITY

- The low center of gravity and full-time eight-wheel drive provide sure-footed traction and maneuverability through demanding terrain and weather conditions
- Integral Rollover Protection Structure (ROPS)
- Smooth steering, zero turn capability and full time traction to all axles

ARGO 8x8 XTI

A fully amphibious all terrain utility vehicle featuring an OHV V-Twin liquid cooled 748cc, 31 hp (23.1 kW), Kohler Aegis LH 775, electronic, fuel-injected engine and ODG patent-pending, triple differential, direct drive ADMIRAL transmission. The XTI has been designed to easily interchange applications and increase utilization in different terrain all year round.

PREMIUM FEATURES

- Multi-position handlebar steering
- 25" ARGO tires for optimum water performance
- Easy access to all critical components for improved serviceability
- Heavy duty axles

For more details visit www.ARGOutv.com/XTI and/or ask your Dealer for the new XTI brochure.

CENTAUR®

Optional dump box

Optional HD rubber track solutions

Optional brushguard, light guards and winch



9" ground clearance

Argo 8x8 XTI NEW

Optional rear bench

Optional 2 or 4 person ROPS

Multi-position handlebar steering

Removable screens

Optional brushguard and winch



9" ground clearance

Optional 15" rubber tracks

VERSATILITY, STRENGTH AND DURABILITY

- Available in tracked or non-tracked configurations
- Upper frame allows for easy accessory mounting options and provides added strength and rigidity to the lower body.
- Adaptable rear platform with optional flat bed for mounting cargo boxes, sprayers, spreaders, apparatus for fire & disaster solutions
- Sealed lower body keeps water, mud and debris out of the drive system, engine and radiator. It is vacuum formed from High Molecular Weight Polyethylene (HMWPE) for superior wear and impact resistance vs. fiberglass or steel (even to temperatures as low as -40°C).

LOW COST OF OWNERSHIP

- Worldwide parts, service and technical support
- Low maintenance
- Optional chain lubrication system

LOW ENVIRONMENTAL IMPACT

- Low pressure tires provide a light footprint on sensitive terrain. Equipped with optional rubber tracks, unladen ground pressures of 1.06 PSI can be attained.

One year limited warranty for body, 3 years for engines

Appearance and specifications subject to change without notice.

COMFORT



CAB HEATER (848-110)
The CENTAUR can be fitted with a 17000 BTU cab heater. Equipped with a 3-speed dual fan motor, this heater will provide operator comfort in the harshest winter conditions.

CONVENIENCE

AUXILIARY ALTERNATOR KIT (849-289)
150 amp auxiliary alternator. Fitted as a stand-alone option, it is belt driven to provide on-demand power when operating ancillary equipment.

CARGO TIE DOWN BARS (849-116)
Six rings mount around the rear compartment



DUMP BOX (835-100)
Mounted to the main frame, the powered dump box improves the load carrying versatility of the CENTAUR.



FLATBED PLATFORM (66" W x 44" L (1675 mm x 1115 mm)). Mounts to the main chassis and is supported by the upper frame. Includes four tie down points and a 32" W x 35" L (810 mm x 890 mm) hatch for easy access to lower body cargo area.

FLATBED OPTIONS

Stake Sides for Wood Panels
Includes nine stakes and pocket rails. Add your own material to finish the sides and rear.

3 Hinged Sides, Steel
10" (255 mm) sides for flatbed. All sides fold down.

2 Stake, Steel Cover + Rear Hinge Steel Covered
Easily removed when not required.

3 Sided Stake With Steel Covering
Side options where all panels are secured via stake pocket rails.

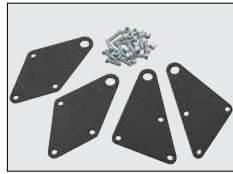

HELICOPTER LIFT KIT (848-121) 4 connection points designed to lift vehicle via helicopter. Designed for remote firefighting, search and rescue and surveying.



LIGHT RACK (848-192)
3 Working Lights. Increase visibility to the cargo area with three manually adjusted swivel lights.



MOUNTING FRAME (849-290)
Optional pre-drilled holes to facilitate mounting of add-on equipment.



RECEIVER WINCH KIT (849-223) The receiver option incorporates a winch brush guard, front and rear receiver mounting brackets and quick disconnect cables.



SNOWPLOW (657-106)
81" (2 m) wide steel blade for straight or angled use. Attaches to the front main frame assembly. Requires power winch option to raise and lower snowplow blade.



4-WHEEL TRAILER
600 lb (270 kg) carrying capacity in a black 6-wheel lower body with ARGO axles and wheels.



WINCH KIT (849-214)
The 4000 lb winch mounts permanently to the front of the vehicle. Reversing, free wheeling out, 40 ft. (12.2 m) steel cable and 30 ft. (9.1 m) nylon strap, safety switch disabled unless ignition is on.

PROTECTION

BILGE PUMP KIT (849-146) Recommended for water crossing. Includes dash-mounted switch and wire harness.



BRUSHGUARD (849-191) Frame mounted and designed to prevent brush and tree limbs from damaging lights and windshield.



CARGO LINER (848-123)
Made from welded steel, the cargo liner is an extension to the existing floor plates and increases lower body protection.



CATWALK MUDFLAPS (850-250) 6/4" (160 mm) steel platform along the length of the vehicle. Includes a 10" (255 mm) mud flap.



LIGHT GUARD (849-134)
Prevents brush and tree limbs from making direct contact with the vehicle driving lights. Installed as a stand-alone item or combine it with the brush guard.



METAL DOORS (848-178)
Metal clad doors. Gas shock-assisted, 90° opening. With "Peep Window" for improved visibility.



MUD FLAP EXTENDERS (821-105) For use with Snow or Multi-Purpose Tracks. Mud flap extenders bolt onto the upper frame assembly to keep mud and snow out of the cargo compartment.

TRANSMISSION OIL HEATER (613-103)
Recommended for use in cold temperatures. This heater plugs into a 110V Power Supply and heats the transmission oil by using a submersed 150 Watt heating element.

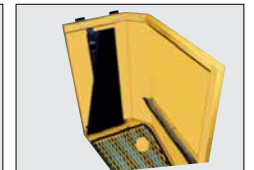

ENGINE COMPARTMENT WINTER PACKAGE (848-179) Complete package includes - Air intake relocated at muffler shield. - Left and right air-flow restrictors across engine bay.

TRACKS

MULTI-PURPOSE TRACKS (849-150) This 15" (381 mm) wide rubber track provides ultimate all terrain performance. Two tire wrap design complete with track tires.

18" (457 mm) RUBBER TRACK (958-88)
Hinged rubber track, rubber sections wrap around 4 tires. Reduces ground pressure to 1.06 psi (7.23 kPa) at full payload.



18" (457 mm) HEAVY DUTY RUBBER TRACK KIT - 2 PCS (958-88HD) Fits over all 4 tires. Features welded steel guides, steel backing plates and heavy duty hinge lacing. Includes reinforced rims with impact resistant 24" turf tires.

18" (457 mm) HEAVY DUTY RUBBER TRACK KIT - 4 PCS (958-88-4HD) Fits over 2 tires, resulting in a 4-track configuration. Features welded steel guides, steel backing plates and heavy duty hinge lacing. Includes reinforced rims with impact resistant 24" turf tires.



SNOW TRACK KIT (849-160) Ladder style, belted snow track, 22" (559 mm) wide for minimal ground pressure, 1.85" (47 mm) steel grouser for max. snow penetration.

THE MOST VERSATILE OFF-ROAD VEHICLES IN THE WORLD

ARGO 8X8 750 HDi

An 8-wheel drive amphibious off-road vehicle with an OHV V-Twin liquid cooled 748cc, 31 hp Kohler Aegis LH 775 electronic fuel-injected engine. It features effective throttle response, excellent fuel economy, reliable cold weather starting and outstanding high-altitude performance.

PREMIUM FEATURES

- Innovative triple differential ADMIRAL steering transmission, available as standard or high torque version, provides even torque to all 8 of the big 25" ARGO tires
- Increased efficiency results in more power to the wheels for optimum performance
- Improved engine compartment cooling
- Large triple sealed bearings
- Heavy duty axles
- Self-adjusting hydraulic vented disk brakes
- Easy-to-remove firewall and floor boards
- Under seat storage and easy access to battery compartment
- Optional suspension seats (standard on 750 HDi Special Edition)

ARGO 8X8 750 HDi Special Edition

All the features of the standard 750 HDi plus:

- 3-way adjustable suspension seating with rear grab handles
- High / low beam headlights
- Signal / side marker lamps
- Front-mounted horn
- Side view mirror
- 7 pin trailer connection
- Heavy-duty alternator
- Entry step



Optional entry step available



Argo 8x8 750 HDi

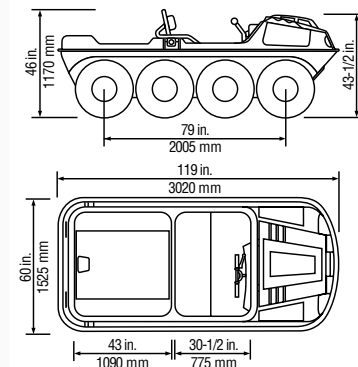

ARGO 8X8 750 HDi / 8X8 700 HD

Argo 8x8 750 HDi

SPECIAL EDITION

ARGO Limited Warranty

One year for vehicles, 3 years for Kohler engines and 2 years for Briggs & Stratton engines.



Argo 8x8 700 HD

ARGO 8x8 700 HD

An 8-wheel drive amphibious off-road vehicle featuring an OHV V-Twin liquid cooled 674cc, 26 hp Kohler Aegis LH 690 engine with electronic ignition and solenoid shift starter. Same premium features as 750 HDi.

FOR 750 HDi AND 700 HD MODELS

STANDARD FEATURES

- Contoured dash design
- Premium foam-padded, hinged, front bench seat (except 750 HDi Special Edition) with easy access to deep storage compartment / toolbox and battery
- One-piece ergonomic handlebar steering control
- Excellent approach and departure angles to easily overcome obstacles
- Innovative design and seating for up to 6 passengers
- Meets all 2013 EPA and CARB "whole vehicle" standards and regulations
- Three-year limited engine warranty
- Easy access to the engine compartment
- Load capacity of up to 1150 lbs on land or 1000 lbs on water

STANDARD EQUIPMENT

- LCD Digital Gauge Cluster* (speedometer, tachometer, odometer, voltmeter, engine coolant temperature, plus low oil pressure and parking brake reminder lights) * ARGO 750 HDi features an additional check engine light
- 25" ARGO tires for optimum traction, smooth ride and better water performance
- Full skid plate for lower body protection
- Convenience group (12 volt outlet, cup holders, grab handle)
- Independent emergency, parking brake

ARGO 8X8 FRONTIER 650

An 8-wheel drive amphibious off-road vehicle powered by a 4 cycle OHV V-Twin air cooled 627cc, 23 hp Cooler Cleaner Briggs & Stratton engine. It features front axle bearing extensions for increased axle and bearing life and has a load capacity of up to 1000 lbs on land or 900 lbs on water.

- State-of-the-art automatic continuously variable transmission with high and low range forward and reverse
- 24" ARGO tires with special tread design
- Premium foam-padded, hinged, front bench seat with easy access to deep storage compartment / toolbox and battery
- Back-up recoil starter
- Large rear cargo capacity
- Heavy duty axles



Argo 8x8 Frontier 650

PERSONALIZE YOUR ARGO

ARGO ACCESSORIES

COMFORT

	6 x 6		8 x 8		
	ARGO 650 HD	FRONTIER 650	ARGO 700 HD	ARGO 750 HDI	ARGO 750 HDI SE
Convertible Top	649-51	849-51	849-40	849-40	849-40
Convertible Half-Top	N/A	N/A	849-45	849-45	849-45
Heater	N/A	N/A	848-170	848-170	848-170
Rear Bench Seat	N/A	849-80	849-80	849-80	849-80
Suspension Seats	N/A	N/A	*	*	Included
Windshield	648-79	648-79	848-171	848-171	848-171
Windshield Wiper	648-91	648-91	648-91	648-91	648-91

CONVENIENCE

Alternator	N/A	N/A	850-54	850-54	Included
Auto Chain Lubrication System	N/A	N/A	850-213	850-213	850-213
Cargo Tie-Down Rings	614-06	614-06	614-06	614-06	614-06
Entry Step	N/A	848-173	848-173	848-173	Included
Gas Can Holder	867-01	867-01	867-01	867-01	867-01
Handrail	639-26	839-35	839-30	839-30	839-30
Helicopter Lift Kit**	865-00	865-00	865-00	865-00	865-00
Mounting Assembly (Brushguard/Winch)	622-107	622-108	622-108	622-108	Included
Outboard Motor Bracket	617-09	617-10	617-10	617-10	617-10
Power Winch	622-110	622-105	622-105	622-105	622-105SE
Receiver Winch (Wiring & Rear Hitch)	622-96	622-96	622-96	622-96	622-96
Remote Control (Winch)	622-106	622-106	622-106	622-106	622-106
Snow Plow Kit	657-21	657-21	657-21	657-21	657-21
Tire Holder	868-01	868-01	868-01	868-01	868-01
Tow Hook Assembly	642-00	642-00	642-00	642-00	Included
Trailer (consult dealer for options)	V-Trailer-11	V-Trailer-11	V-Trailer-11	V-Trailer-11	V-Trailer-11
Trailer Hitch (coupler ball not included)	Included	Included	Included	Included	Included
Utility Bracket	821-25	821-25	821-25	821-25	N/A
Utility Rack	821-35	821-35	821-35	821-35	N/A
Utility Storage Pouch	621-35	621-35	621-35	621-35	621-35

PROTECTION

Bilge Pump	638-40	638-40	638-40	638-40	638-40
Brake / Tail Lights	624-26	624-10	624-26	624-26	Included
Brushguard	642-50	642-50	642-49	642-49	Included
Brushguard for ROPS	642-80	642-80	642-80	642-80	N/A
Cargo Bedliner	N/A	866-01	866-01	866-01	N/A
Debris Screen	N/A	N/A	848-195	848-195	848-195
Fog Lights	648-92	648-92	648-92	648-92	648-92
Hood Fan	N/A	N/A	602-71	602-71	602-71
Mudflaps	N/A	625-10	625-10	625-10	625-10
Reverse Back-up Alarm Kit	850-99	850-99	850-99	850-99	850-99
Roll Bar	648-15	N/A	N/A	N/A	N/A
Roll Bar Lights	648-90	N/A	N/A	N/A	N/A
Rops c/w 2 Seat Belts	648-47	849-90-2	849-90-2	849-90-2	N/A
Rops & Rear Bench Seat	N/A	849-90-4	849-90-4	849-90-4	N/A
Skid Plate	Included	863-13	Included	Included	Included
Storage Cover	621-21	821-40	821-40	821-40	821-40

SEARCH & RESCUE

Basket Mount Adapter (For Ferno RE1125)	N/A	N/A	850-101	850-101	N/A
Stretcher - Ferno #9	N/A	N/A	015-3204ARG	015-3204ARG	N/A
Stretcher Frame	N/A	N/A	850-100	850-100	N/A

TRACKS

Rubber Tracks	625-50	825-50-1	825-50-1	825-50-1	825-50-1
Standard Tracks***	615-43	815-42K	815-42K	815-42K	815-42K
Super Tracks***	625-43	825-42K	825-42K	825-42K	825-42K
Super Track Ice Cleats	625-20	825-21	825-21	825-21	825-21

* Factory Installed Option **Requires 25" Tires

***Standard and Super Tracks require the use of ARGO AT189 24x10.00-8NHS Tires

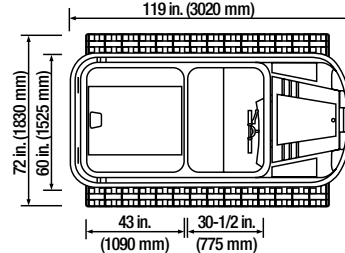
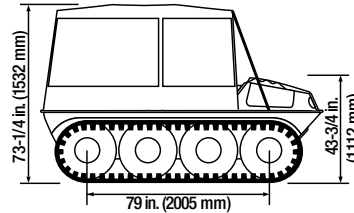
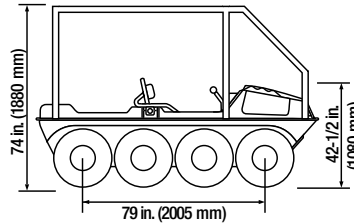

Vehicle shown with accessories,
see specification page for base vehicle.
(ARGO 8x8 750 HDI model shown)

SUPER TRACK: Add 1 in. (25 mm) to vehicle height
RUBBER TRACK: Adds 1-1/4 in. (32 mm) to vehicle height
CONV. TOP: 1-1/2 in. (38 mm) less than ROPS height

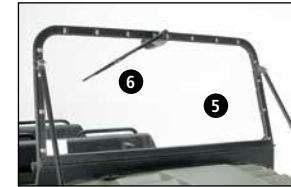

COMFORT

1 Convertible Top

Protects occupants from the weather. Has removable side and rear doors and stores folded down with boot cover. Requires fold-down windshield. (Optional roll bar light cannot be used with full convertible top).

2 Convertible Half-Top

Protects operator and side passenger from the elements. Features removable side and rear doors, allowing easy access to the rear cargo compartment area. Requires fold-down windshield.

3 Rear Bench Seat with Back Rest

For 8x8 models only. Features versatile forward or rear facing position for easy entry/exit when the vehicle is equipped with a convertible top. The seat is more comfortable due to greater foam thickness and density.

4 Suspension Seats

3-way adjustable suspension seats for increased ride comfort.

5 Windshield

Scratch-resistant acrylic in an aluminum frame, features mounting hole for the optional windshield wiper accessory.

6 Windshield Wiper

Complete with everything needed to assemble and fit to your ARGO Windshield. The Wiper Motor mounts quickly and easily, requiring no drilling on newer style predrilled windshields.

CONVENIENCE

Cargo Tie-Down Rings

(Not shown) Six rings mount around the rear compartment (four rings for 6x6 models).

7 Entry Step

Convenient and easy access to the vehicle. Can be mounted in four different positions.

8 Gas Can Holder

Adjustable gas can holder mounted at the rear of the vehicle.

9 Handrails

Tubular steel rails mount around the body, providing hand-hold points for rear passengers.

10 Helicopter Lift Kit

Axle mounted at 4 corners, quick release point for helicopter sling connection.



11 Outboard Motor Bracket
This one-piece bracket mounts at the bumper and onto the trailer hitch bracket. Mounting location is slightly off-center and accepts an outboard motor of up to 9.9 hp for increased propulsion in water. Frontier 580 requires hitch.

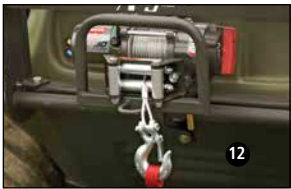

12 WARN Power Winch
For vehicle recovery or to raise and lower plow blade. 3000 lbs (1364 kg) capacity, reversing with free wheeling out, 40' cable with 30' (9M) nylon strap. Safety switch disables winch unless ignition is on.



13 Rear Receiver Winch Accessory
This bracket mounts into the 8x8 trailer hitch receiver, extending the versatility of your winch. Includes instructions and wire harness for installation.



14 Wireless Winch Remote Control
Wireless and compact, this unit can control remote use of winch from a location of up to 50' for added convenience and versatility.

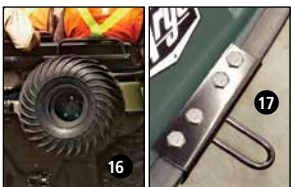

15 Snowplow Kit
81 in. (2 m) wide steel blade features multi-angle positions. Attaches to front bearing extension housings. A snowplow will maximize the utilization of your ARGO. Note: Requires power winch.



16 Tire Holder
Convenient spare tire mount located at the rear of the vehicle.



17 Tow Hook
This versatile accessory is easy to install and allows winch cables or towing straps to be attached to your ARGO.

PROTECTION

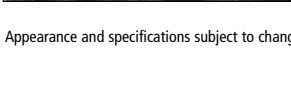

18 Bilge Pump
This accessory is highly recommended for amphibious use of any ARGO. Operated by a dash mounted switch, the pump quickly removes water from the lower body.



19 Cargo Bedliner
Protect your cargo storage space. Simple installation, removable and easy to clean.

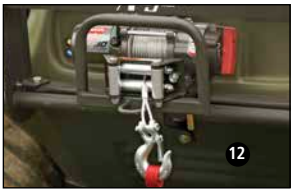

20 Brushguard
Installation of mounting assembly or power winch is required. The 8x8 700HD/750HDi Brushguard features an integrated tow hook and mounting tabs for fog light kit.



21 Brushguard for ROPS
Primarily designed to be installed with the ROPS.

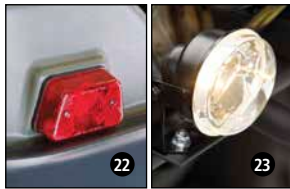

22 Brake/Tail Lights
Brake / Tail lights, complete wire harness and all necessary mounting hardware.



23 Fog Lights
Provides added illumination in poor visibility due to rain, fog, dust or snow.



Hood Fan (Not shown) Extracts hot air from engine compartment (in extreme heat conditions).



Mudflaps (Not shown) Deflects snow and mud out of rear cargo compartment. Stay dry and clean when navigating through challenging terrain. Mounts easily to lower body.



24 Rollover Protection Structure (ROPS) Powder-coated tubular steel frame provides rollover protection and seat belts for driver and front seat passenger.



ROPS & Rear Bench Seat (Not shown) Protects the driver, front seat passenger, and two rear passengers by using the rollover protection structure. Includes rear bench and four seat belts.



25 Roll Bar
Add a distinctive look to your ARGO. Protects driver and passenger. (Reduces seating capacity to 2). Comes with two seat belts and fits all 6x6 models.

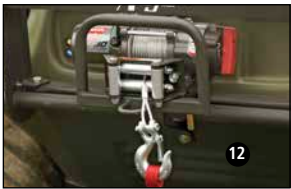

26 Roll Bar Lights
2 rubber mounted, shock resistant 3x5" weatherproof lamps, easily installed on your existing roll bar.



27 Skid Plate
Formed from black high-density polyethylene to protect the lower body of the ARGO. Adding a skid plate to your ARGO will provide added insurance against lower body damage.



28 Storage Protective Covers
Fits all production models without roll bar or ROPS.

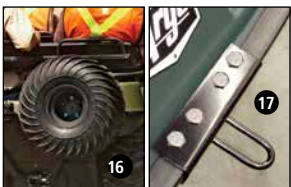

29 4-Wheel Amphibious Trailer
600 lb (270 kg) carrying capacity in a black 6-wheel lower body with ARGO axles and wheels. Ideal for tools, wood, equipment and any extra cargo.



30 Utility Bracket
The Utility Bracket consists of two "Rugged Gear" utility hooks and a barrel holder. It is an ideal way to safely secure objects such as shovels, fishing rods, paddles, etc. to the outside or inside of your ARGO.



31 Utility Rack
The Utility Rack is comprised of two formed flatbar brackets, four "Rugged Gear" utility hooks, and all mounting hardware necessary to attach the bracket to the backrest handrail and upper body. This rack accessory allows two rifles or shotguns to be carried on the inside of the vehicle.



32 Utility Storage Pouch
Dome snaps attach to backrest for convenient storage space. Ideal for keeping first aid kits, tools, electronics and other items safe, clean and easily accessible.



Optima Battery (Not shown) Optional maintenance-free Optima spill-proof battery. Part# for ARGO 613-161 Part# for Centaur 613-160



TRACKS



33 Rubber Tracks
Lightweight and durable construction, combined with low rolling resistance to ensure smooth, quiet operation in most difficult terrain conditions. The 18" track width provides optimum floatation and minimal ground pressure while the tread design offers exceptional traction on various hard and soft surfaces.



34 Super Tracks
18" (45.5cm) wide plastic segments go over 24" ARGO tires, to provide optimum floatation over deep snow.



35 Standard Tracks
13" (32.5cm) wide plastic segments go over 24" ARGO tires, reducing ground pressure for travel over snow or flooded areas.

Super Track Ice Cleats (not shown) Steel cleats increase traction on ice and hardpacked snow.

SEARCH & RESCUE



36 ARGO Stretcher Kit
Designed to accept Ferno #9 stretcher. Fits ARGO 8x8 700 HD and 750 HDi models. Stretcher kit can be adjusted to allow repositioning of frontbench seating. Backrest is folded down for stretcher use and can be put back in upright position when stretcher is not in use.

For information on ARGO 8x8 XTI accessories visit www.ARGOutv.com/XTI



SPECIFICATIONS

CENTAUR

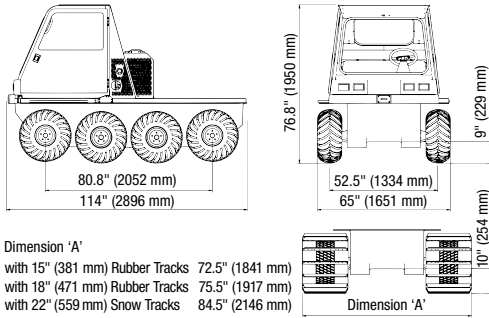

AVAILABLE CENTAUR COLORS



ARGO 8x8 XTI

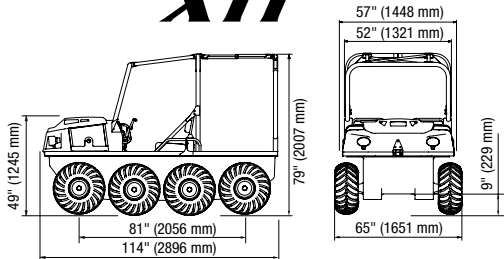

AVAILABLE XTI COLORS



COLOR OPTIONS FOR ALL STEEL PARTS

- Textured Black
- Ultra Chrome / Clear Coat
- Zinc / Textured Black
- Zinc / Ultra Chrome / Clear Coat

Custom coatings and colors are available upon request.

MODEL

CENTAUR-DT

ENGINE	Briggs & Stratton Daihatsu
TYPE	Turbo diesel, in-line 3 cylinder, 4 cycle, liquid cooled
HORSEPOWER¹	34 hp (25.3 kW) @ governed 3800 rpm
DISPLACEMENT	952 cc (58 cu. in.)
TORQUE	58 lbs ft (78.6 Nm)
ELECTRICAL	12 volt, 60 amp alternator, 960 CCA battery, dash mounted glow-plug-on and water in-fuel indicators
BRAKES	Hydraulic disc brake with hand operated mechanical parking brake.
STEERING	Conventional steering wheel. Skid steered via Centaurmatic Transmission.
CONTROLS	Dash mounted HI, LOW and REV gear selector with floor mounted accelerator and brake pedals
LCD DIGITAL GAUGE CLUSTER	Speedometer, Odometer, Voltmeter, Hourmeter, Tachometer, Engine Coolant, Temperature, Low Oil Pressure, Parking Brake Reminder, Check Engine Lights, Water in Fuel Indicator and Preheat Timer.
CLUTCH & TRANSMISSION	Continuously variable belt driven torque converter (CVT) Dual differential transmission, HI, LOW, NEUTRAL and REV.
FINAL DRIVE SYSTEM	RC80 roller chains from transmission to eight 1.5" (38 mm) diameter axles Automatically adjusting tensioner for each drive chain. Tapered roller bearings in an oil bath support each axle. Standard semi-automatic or optional automatic chain lubrication system.

FRAME	Powder coated, 3" (76 mm) tubular steel, lower body support pan, welded construction - FEA analyzed for strength and durability.
--------------	--

BODY	Vacuum formed lower hull and standard full skid plate formed from high molecular weight polyethylene (HMWPE)
-------------	--

LOAD CAPACITY	1,500 lbs (680 kg) on land
----------------------	----------------------------

DRAWBAR PULL²	2,000 lbs (907 kg)
---------------------------------	--------------------

TOWING CAPACITY	2,000 lbs (907 kg)
------------------------	--------------------

SEATING CAPACITY	Front bench seat for two persons
-------------------------	----------------------------------

FUEL CAPACITY	12.6 U.S. gal. (48 litres) providing approx. 10 hours of operation
----------------------	--

SPEED³	25 mph (40 km/h)
--------------------------	------------------

SHIPPING WEIGHT⁴	2,200 lb (1,000 kg) base vehicle 2,520 lbs (1,143 kg) with multi-purpose tracks 2,720 lbs (1,234 kg) with snow tracks
------------------------------------	---

LENGTH	114" (2,896 mm)
---------------	-----------------

WIDTH	with Tires 65" (1,651 mm) with 15" (381 mm) Rubber Tracks 72.5" (1,841 mm) with 18" (471 mm) Rubber Tracks 75.5" (1,917 mm) with 22" (559 mm) Snow Tracks 84.5" (2,146 mm)
--------------	---

HEIGHT	76.8" (1,950 mm)
---------------	------------------

TIRES	HEAT AT190 25x12.00-9 NHS High impact resistant 24" turf tires with reinforced rims (for track use only)
--------------	---

GROUND PRESSURE	with Tires as low as 5 psi (34 kPa) with 15" (381 mm) Rubber Tracks 2.2 psi (15 kPa) with 18" (471 mm) Rubber Tracks 1.27 psi (8 kPa) with 22" (559 mm) Snow Tracks 1.0 psi (6.8 kPa)
------------------------	--

GROUND CLEARANCE	9" (229 mm) to center of lower body
-------------------------	-------------------------------------

OPERATING CONDITIONS	All weather, all terrain, -40°F to +104°F (-40°C to +40°C)
-----------------------------	--

TRANSPORT	Truck, trailer or helicopter lift
------------------	-----------------------------------

ARGO 8x8 XTI

ENGINE	Kohler Aegis LH 775
TYPE	V-Twin 4 cycle petrol, liquid cooled
HORSEPOWER¹	31 hp (23.1 kW) @ governed 3600 rpm
DISPLACEMENT	748cc (45.6 cu. in.)
TORQUE	47.7 lbs ft (64.6 Nm)
ELECTRICAL	Dual 12 V outlet, 40 amp alternator, AGM 775 CCA Group 34 battery
BRAKES	Hydraulically activated disc brakes, ratcheting style mechanical park brake
STEERING	One piece, multi-position, ergonomic handlebar steering control
CONTROLS	One piece, multi-position handlebar steering control with centre mount, analog dash panel. Forward, Neutral and Reverse with HI and LOW selection.
LCD DIGITAL GAUGE CLUSTER	Tachometer with Digital Hour Meter, Speedometer with Digital Odometer, Fuel Gauge, Volt Meter, Water Temperature, Park Brake ON, Low Oil Pressure, Check Engine Warning
CLUTCH & TRANSMISSION	Continuously Variable Transmission (CVT) with heavy duty drive belt Direct drive, ADMIRAL triple differential steering transmission
FINAL DRIVE SYSTEM	RS60 HT heavy series roller chain connects 8 axles to the ADMIRAL transmission. Automatically adjusting tensioner for each drive chain. 1.50" (38 mm) diameter axles housed in an oil filled aluminum housing. Optional automatic chain lubrication system.

FRAME	Powder coated, 3" (76 mm) tubular steel, lower body support pan, welded construction - FEA analyzed for strength and durability.
--------------	--

BODY	Vacuum formed lower hull and standard full skid plate formed from high molecular weight polyethylene (HMWPE)
-------------	--

LOAD CAPACITY	1,500 lbs (680 kg) on land, 1,000 (454 kg) on water
----------------------	---

DRAWBAR PULL²	1,150 lbs (520 kg)
---------------------------------	--------------------

TOWING CAPACITY	1,800 lbs (816 kg)
------------------------	--------------------

SEATING CAPACITY	2 persons (4 persons optional) on land and water
-------------------------	--

FUEL CAPACITY	9.5 U.S. gal. (36 litres) providing approx. 8- 10 hours of operation
----------------------	--

SPEED³	17 mph (27 km/h) on land, 3 mph (5 km/h) on water
--------------------------	---

SHIPPING WEIGHT⁴	1,600 lbs (725 kg) base vehicle 1,920 lbs (871 kg) with multi-purpose tracks
------------------------------------	---

LENGTH	114" (2,896 mm)
---------------	-----------------

WIDTH	65" (1,651 mm) 72.5" (1,841 mm) 75.5" (1,917 mm) N/A
--------------	---

HEIGHT	49" (1,245 mm)
---------------	----------------

TIRES	ARGO AT189 25x12.00-9 NHS High impact resistant 24" turf tires with reinforced rims (for track use only)
--------------	---

GROUND PRESSURE	as low as 2.8 psi (20.5 kPa) 1.9 psi (12.95 kPa) 1.06 psi (7.23 kPa) N/A
------------------------	---

GROUND CLEARANCE	9" (229 mm) to center of lower body
-------------------------	-------------------------------------

OPERATING CONDITIONS	All weather, all terrain, -40°F to +104°F (-40°C to +40°C)
-----------------------------	--

TRANSPORT	Truck, trailer or helicopter lift
------------------	-----------------------------------

1 Gross intermittent SAE J1349

2 Towing capacity is approximate and depends on terrain, load on vehicle, incline and decline

3 All speeds are approximate and depend on conditions

4 Weights are approximate and will vary depending on final specification

Design and specifications subject to change without notice.

Options may not be exactly as shown.

Updated information is available on-line:

www.centaur8x8.ca and www.ARGOutv.com



6x6 650 HD



8x8 FRONTIER 650



8x8 700 HD

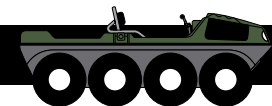

8x8 750 HDi 8x8 750 HDi SE

ENGINE	Briggs & Stratton Vanguard 2 year warranty		Briggs & Stratton Vanguard 2 year warranty		Kohler Aegis LH 690 3 year warranty		Kohler Aegis LH 775 3 year warranty	
TYPE	4 cycle OHV V-Twin gasoline engine, electronic ignition, full pressure lubrication and oil filter							
HORSEPOWER	23		23		26		31	
DISPLACEMENT	627cc		627cc		674cc		748cc	
COOLING	Air Cooled		Air Cooled		Liquid Cooled		Liquid Cooled	
STARTING	Electric/Recoil		Electric/Recoil		Electric		Electric	
BRAKES	Hydraulic		Hydraulic		Hydraulic		Hydraulic	
STEERING	One-piece ergonomic handlebar steering control with hand brake. For safety and ease of handling, the ARGO steering transmission provides continuous torque to all axles.							
CONTROLS	Right-hand twist grip throttle and dash-mounted choke control (Except HDi models). Light switch and ignition switch.							
LCD DIGITAL GAUGE CLUSTER	Speedometer, Odometer, Voltmeter, Hourmeter, Tachometer, Low Oil Pressure and Parking Brake Reminder Lights				Speedometer, Odometer, Voltmeter, Hourmeter, Tachometer, Engine Coolant Temperature, Low Oil Pressure and Parking Brake Reminder Lights (ARGO 8x8 750 HDi & 750 HDi SE also feature a Check Engine Light)			
CLUTCH	Belt-driven, Continuously Variable Transmission (CVT) maximizes engine power to the transmission.							
TRANSMISSION	ADMIRAL®		Planetary®		ADMIRAL®		ADMIRAL®	
DRIVE SYSTEM	Roller chains drive machined sprockets that are spline-fit onto 1/4" diameter axles and are protected with triple-sealed greaseable bearings.							
FRAME	Formed steel channel construction, welded for high strength and durability. Polyester powder-coated for lasting protection.							
BODY	Vacuum formed High Molecular Weight Polyethylene							
FULL SKID PLATE	Standard		Optional		Standard		Standard	
LOAD CAPACITY¹	700 lbs / 317 kg total²		1,000 lbs / 454 kg total		1,150 lbs / 521 kg total		1,150 lbs / 521 kg total 1,000 lbs / 454 kg total	
REAR COMPARTMENT ON WATER	140 lbs (63 kg) max.		900 lbs / 408 kg total		1,000 lbs / 454 kg total		1,000 lbs / 454 kg total 850 lbs / 386 kg total	
TOWING CAPACITY³	1,400 lbs / 635 kg		1,400 lbs / 635 kg		1,800 lbs / 818 kg		1,800 lbs / 818 kg	
SEATING CAPACITY⁴	4 persons		6 persons		6 persons		6 persons	
ON WATER	2 persons		4 persons		4 persons		4 persons	
FUEL CAPACITY	7.1 US gallons (27 litres) See-through polyethylene fuel tank. 8 hours of operation⁵							
SPEED⁶	22 mph / 35 km per hour		19 mph / 30 km per hour		20 mph / 32 km per hour		20 mph / 32 km per hour	
ON WATER⁷	3 mph / 5 km per hour		3 mph / 5 km per hour		3 mph / 5 km per hour		3 mph / 5 km per hour	
SHIPPING WEIGHT	890 lbs / 404 kg		1,050 lbs / 476 kg		1,250 lbs / 570 kg		1,250 lbs / 570 kg 1,410 lbs / 641 kg	
DIMENSIONS (L x W x H) (inches)	95 x 58 x 45.8		119 x 58 x 46.5		119 x 60 x 46		119 x 60 x 46	
(mm)	2,413 x 1,473 x 1,163		3,020 x 1,473 x 1,180		3,020 x 1,525 x 1,170		3,020 x 1,525 x 1,170	
AXLE BEARING EXTENSIONS	Front - Standard Rear - Standard		Front - Standard Rear - Optional		Front - Standard Rear - Standard		Front - Standard Rear - Standard	
TIRES	ARGO AT189 24x10.00-8NHS		ARGO AT189 24x10.00-8NHS		ARGO AT189 25x12.00-9 NHS		ARGO AT189 25x12.00-9 NHS	
GROUND PRESSURE	2.1 psi (14.5 kPa) using tires 0.67 psi (4.6 kPa) using tracks							
GROUND CLEARANCE	9.5" (240 mm)		9" (230 mm)		9.5" (240 mm)		9.5" (240 mm)	
TIRES TRACKS	10.5" (265 mm)		10" (255 mm)		10.5" (265 mm)		11" (279 mm)	
OPERATING CONDITIONS	All weather, all terrain, -40°C to +40°C							

- Capacity includes occupants, cargo, outboard motor and fuel, and installed accessories. Max. outboard motor size 7.4 kW (9.9 hp).
- Total payload is 700lbs with max. 140lbs allocated to rear compartment.
- Towing capacity is approximate and depends on type of surface, load on vehicle as well as incline. Max Hitch Tongue Load (when equipped with hitch) 100 lbs / 45kg for all models
- Subject to rear compartment load capacity limitations.
- Fuel consumption depends on load and operating conditions.
- All speeds are approximate and depend on conditions.
- Always wear approved Personal Floatation Device (PFD) when operating in water or on ice.
- ADMIRAL triple differential steering transmission with dedicated Hi and Low selector; Forward, Neutral, Reverse.
- Planetary differential transmission with High and Low range; Forward, Neutral, Reverse

AVAILABLE ARGO COLORS

*Colors in this brochure are reproduced with great care, but may vary slightly from actual ARGO vehicle colors.



Appearance and specifications subject to change without notice.

COLOR OPTIONS FOR ALL STEEL PARTS

- Textured Black
- Ultra Chrome / Clear Coat
- Zinc / Textured Black
- Zinc / Ultra Chrome / Clear Coat

CUSTOM COATINGS AND COLORS ARE AVAILABLE UPON REQUEST.

A WORLD LEADER IN AMPHIBIOUS VEHICLES

ARGO vehicles are your best choice for extreme off-road use! From the amphibious capabilities of the ARGO HDI to the versatility of the ARGO XTI, no other vehicle can satisfy so many needs. Search & rescue teams, utility companies, exploration companies, surveyors, forestry managers and the defense sector all benefit from the unique abilities of ARGO vehicles. **ARGO provides extreme vehicle solutions unmatched in the off-road industry.**

Since 1967, ARGO has been manufactured by ODG in New Hamburg, Ontario, Canada at ODG's 121,500 sq. ft. (11,350 m²) facility. Our dedicated team of engineers, production and technical support staff has made ARGO **the most reliable, amphibious, off-road, utility vehicle** you will ever drive.



Development



Precision Manufacturing



Quality Assurance



Technical Support



ODG
220 Bergey Court, New Hamburg,
ON, Canada N3A 2J5
Toll Free: **1-877-274-6288**
Tel: (519) 662-4000 • Fax: (519) 662-2421
www.ARGOutv.com

Proud to be located in
Canada's
Technology
Triangle

Safety!
...always in Season!

tread lightly!
ON LAND AND WATER



WARNING: All operators appearing in this brochure are highly skilled ARGO and CENTAUR drivers. The ARGO and CENTAUR are powerful off-road vehicles and can be dangerous if not properly operated or maintained. Before operating for the first time, read the Operator's Manual thoroughly to make certain all details and recommended driving procedures are clearly understood. Do NOT allow any individual to ride in or operate vehicle without first reading and clearly understanding the procedures outlined in the Operator's Manual. Do NOT allow any individual under 16 years of age to operate vehicle. Do NOT attempt maneuvers on terrain beyond your skills or beyond the capabilities of ARGO or CENTAUR. Do NOT operate the vehicle on highways, or any other road system. For safety, we recommend the wearing of helmets and eye protection. When operating in water follow standard boating safety procedures, always wear approved Personal Floatation Devices and do not stand in a floating ARGO or CENTAUR. Operating your vehicle on ice-covered bodies of water can be dangerous. Always consult your Operator's Manual for detailed safety precautions. Follow all instructions that appear on the CAUTION and WARNING plates. Do NOT exceed the recommended MAXIMUM load capacity under any circumstances. Do NOT operate the vehicle unless all occupants are seated and all cargo is securely fastened down. Drive with CAUTION and good sense at all times.

Authorized Dealer